



FIGURA		Nº Lontra	Modelo Compatível	Descrição e Aplicação	
	Kpxx Comprimento G:xxx	<b>KPX-XX</b> 1.X-X-X 2.X-X-X 3.X-X-X	00000000	XXXXXXXXXXXXXX	
<b>EXEMPLO</b>					
FIGURA		Nº Lontra	Modelo Compatível	Rosca	Descrição e Aplicação
A:xxx B:xxx C:xxx D:xxx	 E:xxx F:xxx	<b>KPX-XX</b> 1.X-X-X 2.X-X-X 3.X-X-X	00000000	XXXX	XXXXXXXXXXXXXX

**Figura:** Identifica o visual do produto.\*

**A/B/C/D/E/F/G:** Identifica as dimensões do produto quando existir.

**KPxxx:** Terminal correspondente instalado no produto.

**Nº Lontra:** Identifica o número do produto.

- 1** - Equivalência TRW quando existir;
- 2** - Equivalência Driveway quando existir;
- 3** - Equivalência Nakata quando existir.

**Modelo Compatível:** Identifica o produto pelo código de produtos do fabricante.

**Rosca:** Identifica se é rosca esquerda ou direita quando for o caso.

**Descrição e Aplicação:** Identifica a nomenclatura do produto e em que modelo compatível do fabricante se aplica.

\*A figura dos produtos estão em escalas diferentes.

## DIMENSÕES

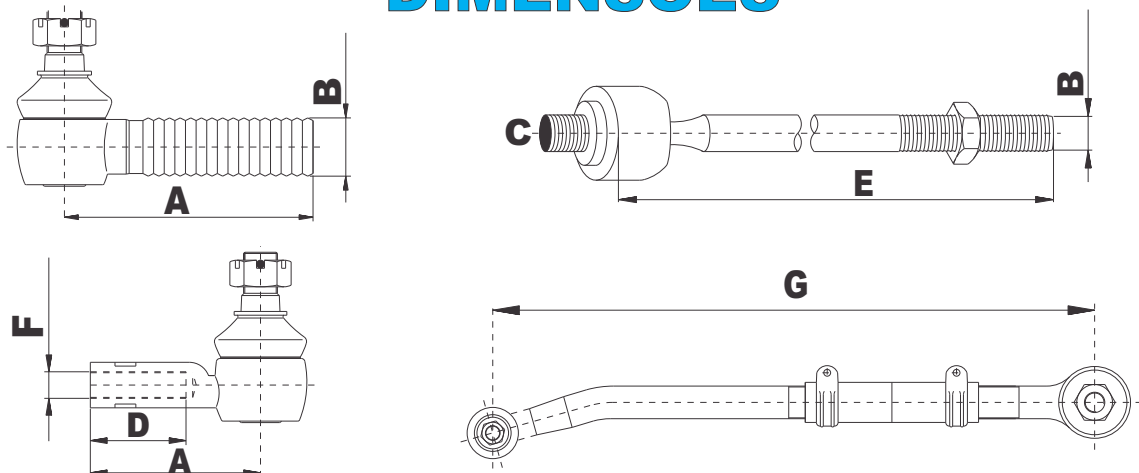

## QUALIDADE QUE VOCÊ CONHECE, AGORA CERTIFICADA.

Apresentamos a todos os parceiros os nossos primeiros certificados de conformidade do INMETRO e ISO 9001-2008 de 2015. Os produtos que já desfrutavam de toda a confiança do mercado, agora com certificação, o que enche de orgulho toda a equipe de colaboradores da King Parts e seus distribuidores.

**CERTIFICADO DE CONFORMIDADE**  
Conformity Certificate

**Nº 23.008/15**

A ABNT concede o Certificado de Conformidade de Sistema de Gestão da Qualidade à empresa:  
ABNT grants the Conformity Certificate of the Quality Management System to the company:

**K Parts Indústria e Comércio de Peças Ltda**  
CNPJ: 07.749.651/0001-28

Implementado para a(s) atividade(s) de:  
Implemented for the following activity(ies):

**Desenvolvimento, fabricação, venda e comercialização de peças automotivas e agrícolas e fabricação e venda de peças usinadas**

Exercida(s) na unidade localizada em:  
Exercised in the unit located in:

**Rua Dr. Rene Fernandes, 415B - Vila Loroque**  
04327-180 - São Paulo - SP

Atendendo aos requisitos da Norma:  
Meeting the requirements of the Standard:

**ABNT NBR ISO 9001:2008**

Primeira concessão: 15/01/2015  
First concession:

Período de validade:  
Validity period:

**15/01/2015 a 15/01/2018**

Rio de Janeiro, 19 de janeiro de 2015

*Guy Ladvocat*  
Gerente de Certificação de Sistemas  
Systems Certification Manager

Este certificado é suportado por contrato de atendimento à Norma e procedimento da ABNT e é válido somente em original e com o selo da ABNT em alto-relevo ao lado, assinado pelo Gerente de Certificação de Sistemas. Sua validade pode ser confirmada no seguinte endereço eletrônico: [www.abnt.org.br](http://www.abnt.org.br)  
This certificate is supported by a contract of compliance with ABNT Standard and procedure and will be valid only in original form and with the ABNT stamp in its high-relief side signed by the Systems Certification Manager. Its validity may be confirmed at the following electronic address: [www.abnt.org.br](http://www.abnt.org.br)

ABNT - Associação Brasileira de Normas Técnicas  
Av. Treze de Maio, 13 - 28º Andar - Centro - Rio de Janeiro - RJ - CEP 20031-901  
Av. Paulista, 726 - 10º Andar - Bela Vista - São Paulo - SP - CEP 01310-910

Rev.: 04

**CERTIFICADO DE CONFORMIDADE**  
Conformity Certificate

**Nº 363.001/15**

A ABNT concede o Certificado de Conformidade de Produto à empresa:  
ABNT grants the Product Compliance Certificate to the company:

**K Parts Indústria e Comércio de Peças Ltda**  
Marca: **Lontra**  
CNPJ: 07.749.651/0001-28

Para o(s) produto(s):  
To the following product(s):

**Componentes Automotivos - Terminais de Direção e Terminais Axiais**  
(Conforme modelos especificados no anexo)

Relatórios de Ensaios			
Terminal de Direção	Data	Terminal Axial	
Nº		Nº	Data
1885.14EE_00	15/12/14		
1884.14EE_00	17/12/14		
1885.14EE_00	14/12/14	1885.14EE_00	15/12/14
1887.14EE_00	15/12/14		

Produzido(s) na unidade localizada em:  
Produced in the unit located in:

**Rua Doutor Rene Fernandes 415 B - Vila Loroque**  
04327-180 - São Paulo - SP

Atendendo aos requisitos do Procedimento Específico ABNT:  
Meeting the requirements of specific procedure ABNT:

**PE-245.07**

Atendendo aos requisitos da Portaria INMETRO:  
Meeting the requirements of the INMETRO Ordinance:

**Requisitos de Avaliação da Conformidade**  
Portaria Inmetro nº 301 de 21/07/2011  
Portaria Inmetro nº 288 de 28/05/2013

Modelo de Certificação: Modelo 5  
Certification Model 5

Primeira concessão do certificado: 12/01/2015  
First grant of the certificate:

Período de validade do certificado:  
Validity period of the certificate:

**12/01/2015 a 12/01/2019**

Rio de Janeiro, 15 de janeiro de 2015

*Sergio Pacheco*  
Gerente de Certificação de Produto  
Product Certification Manager

A validade deste certificado está atrelada à realização das avaliações de manutenção e tratamento de não-conformidade de acordo com as orientações da ABNT previstas no procedimento específico. Este certificado está sujeito ao controle periódico do Procedimento Geral para Avaliação da Conformidade, ao Procedimento Específico da Marca de Conformidade ABNT bem como aos requisitos da Portaria acima, sendo válido somente em original e com o selo da ABNT em alto-relevo ao lado, assinado pelo Gerente de Certificação de Produto, e sua validade pode ser confirmada no seguinte endereço eletrônico: [www.abnt.org.br](http://www.abnt.org.br). Este certificado está vinculado ao contrato nº 363.CP.002/14, e para o endereço acima citado. CNPJ: 03.422.832/0001-09 - Tel: (21) 3974-2300 / Fax: (21) 3974-2315.  
The validity of this certificate is tied to conducting maintenance and non-conformance treatment in accordance with the instructions issued by ABNT in the specific procedure. This certificate is subject to the periodic control of the General Procedure for Conformity Assessment, and to the Specific Procedure of the ABNT Conformity Mark, as well as to the Environmental Director's instructions and will be valid only in its original form, with the ABNT stamp on its high-relief side, signed by the Product Certification Manager, and its validity may be confirmed at the following electronic address: [www.abnt.org.br](http://www.abnt.org.br). This certificate is related to the contract nº 363.CP.002/14.

ABNT - Associação Brasileira de Normas Técnicas  
Av. Treze de Maio, 13 - 28º Andar - Centro - Rio de Janeiro - RJ - CEP 20031-901  
Av. Paulista, 726 - 10º Andar - Bela Vista - São Paulo - SP - CEP 01310-910

Rev.: 01

**INMETRO**  
Nº 363.001/15

**ABNT NBR ISO 9001:2008**  
concessão: 15/01/2015

HÁ 55 ANOS FORJANDO O FUTURO DO BRASIL



# ÍNDICE

Conversão N°Lontra x Modelos Compatíveis.....	02 a 03
Conversão Modelos Compatíveis x N°Lontra.....	04 a 05

## CAMINHONETES

Toyota.....	06 a 12
Mitsubishi.....	13 a 16
Ford.....	17 a 24
Chevrolet.....	25 a 29
Land Rover.....	30
Volkswagen.....	31
Nissan.....	32
Dodge.....	33

## VANS / UTILITÁRIOS

Mercedes-Benz.....	34 a 36
Kia.....	37
Hyundai.....	38 a 39
Iveco.....	40
Fiat.....	40
Renault.....	41
Agrale.....	42

**AGRALE**

Nº LONTRA	MODELO COMPATÍVEL	PÁG
KPCZ-177	6007009321000	42
KPCZ-210	6006069009003	42
KPCZ-252	6003009007004	42
KPCZ-254	6007009321000	42
KPCZ-266	6006009009003	42
KPA-702	6006007016000	42
KPA-702	6007007331001	42
KPA-703	6006007017008	42
KPA-710	6006007132005	42
KPA-711	6006007133003	42
KPA-781	6007007331001	42
KPA-782	6008007716001	42

**CHEVROLET**

Nº LONTRA	MODELO COMPATÍVEL	PÁG
KPCZ-121	7352431	29
KPCZ-121	7364605	29
KPCZ-121	94622086	29
KPCZ-210	7634605	29
KPCZ-256	522700196	29
KPG-080	52258111	27
KPG-080	7323877	27
KPG-080	7330710	27
KPG-167	52258112	27
KPG-167	7323878	27
KPG-167	9304148	27
KPG-703	93213068	27
KPG-703	94630474	27
KPG-707	93213067	27
KPG-707	94630475	27
KPG-848	93281740	27
KPG-848	93230827	27
KPG-848	92328935	27
KPG-867	93292476	27
KPG-870	93331416	27
KPG-875	93328935	27
KPG-875	93331496	27
KPG-875	93314316	27
KPG-900	94727113	27
KPG-901	94727114	27
KPG-1049	9297512	26
KPG-1049	9297513	26
KPG-1050	7324559	26
KPG-3117	3826596	25
KPG-3117	9297515	25
KPG-3117	7317470	25
KPG-3118	9297514	25
KPG-3249	52286801	26
KPG-3250	52286801	26
KPG-3251	3986724	25
KPG-3251	94648487	25
KPG-3252	52252914	25
KPG-4036	26033089	25
KPG-4037	26033088	25
KPG-4040	-	26
KPG-4041	94772911	26
KPG-4045	94772911	25
KPG-6000	26046110CG	28
KPG-6001	26046110CP	28
KPG-6010	3817956	28
KPG-6020	3767052	28
KPG-6021	94634079	28
KPG-6022	94634078	28
KPG-6023	94651679	28
KPG-6027	52256814	28
KPG-6029	93360627	28
KPG-8007	94644439	28
KPG-8008	94644440	28

**DODGE**

Nº LONTRA	MODELO COMPATÍVEL	PÁG
KPD-1000	-	33
KPD-1001	-	33
KPD-1002	-	33
KPD-1003	-	33
KPD-2300	-	33
KPD-2301	-	33
KPD-2302	-	33
KPD-3300	-	33
KPD-3301	-	33
KPD-3302	52122362AE	33

**FORD**

Nº LONTRA	MODELO COMPATÍVEL	PÁG
KPCZ-120	83PU4758A	24
KPCZ-121	86D7039A	24
KPCZ-121	BCOC7039A	24
KPCZ-121	CD4D7039A	24
KPCZ-121	BE2C7039A	24
KPCZ-210	ACOT7039A	24
KPCZ-252	BD2Y47039A	24
KPCZ-291	-	24
KPCZ-292	-	24
KPFD-215	C7TZ3280B	20
KPFD-215	C7TZ3280H	20
KPFD-218	C7TZ3A130A	17
KPFD-218	85TU3289B	17
KPFD-219	C7TZ3A131A	17
KPFD-219	85TU3290B	17
KPFD-223	86TU3280EB	20
KPFD-224	86TU3290CA	17
KPFD-225	86TU3289CA	17
KPFD-228	B11399	17
KPFD-229	A847	17
KPFD-230	A838	17
KPFD-726	85TU3280	20
KPFD-726	85TU3280B	20
KPFD-726	C77A3280H	20
KPFD-0735	E7TA3B102AA	22
KPFD-0735	E7TZZ3049A	22
KPFD-0736	E7TA3B102DA	22
KPFD-0737	TNK407303	22
KPFD-0737	F5UZ3049A	22
KPFD-0738	TNK407301	22
KPFD-0739	F6TZ3050FB	22
KPFD-0740	E3TZZ3050AA	22
KPFD-0741	5L553395AA	22
KPFD-0742	2L5Z3083AA	22
KPFD-0742	F5TZ3083A	22
KPFD-0743	2L5Z3082AA	22
KPFD-0743	F87A3084CA	22
KPFD-0745	Nº DA BANDEJA INFERIOR DB393091BA	23
KPFD-0746	Nº DA BANDEJA SUPERIOR DB393084BA	23
KPFD-0747	YC153468AF	23
KPFD-0748	BF8T3049A5	23
KPFD-0749	BF8T3049AI	23
KPFD-0750	BF8T3049A	23
KPFD-0971	C5TA3A131A	17
KPFD-0971B	C5TZ3280A	20
KPFD-0972	Z8TU3289A	17
KPFD-0975	F2TZ3A131C	17
KPFD-0976	F2TZ3A131F	17
KPFD-0977	F2TZ3A130E	17
KPFD-0978	F87Z3A130BA	18
KPFD-0979	F5TZ3280AA	18
KPFD-0980	-	18
KPFD-0984	UC2N32290	18
KPFD-0984	AB313290BA	18
KPFD-0985	UC2N32280	18
KPFD-0985	AB313289BA	18
KPFD-0986	UC2M3224XA	18
KPFD-0986	AB313280AB	18
KPFD-0987	6CL3L519AA	18
KPFD-0987	6CL3L519BA	18
KPFD-0988	6C11/3289AC	18
KPFD-2056	C7TZ3304GC	20
KPFD-2303	BE2C3304A	20
KPFD-2303	79TU3304A	20
KPFD-3115	86TU3304GB	20
KPFD-3373	BF2C3280A	20
KPFD-3374	BF2C3304A	20
KPFD-3376	F2TZ3304C	20
KPFD-3377	-	21
KPFD-3378	-	21
KPFD-3379	2C353B0008BA	21
KPFD-3380	2C353B406BA	18
KPFD-3381	2C353B407BA	18
KPFD-3382	2C353289BA	18
KPFD-3383	2C353290BA	18
KPFD-3399	BF2C3289C	19
KPFD-3400	BF2C3290C	19
KPFD-3406	BF2C3289B	19
KPFD-3409	BF2C3290B	19
KPFD-3410	2C353B406AA	19
KPFD-3411	F813304AA	19
KPFD-3495	T72415701	21

**FORD**

Nº LONTRA	MODELO COMPATÍVEL	PÁG
KPFD-3612	1C3Z3A131BA	19
KPFD-3613	1C3Z3A131BA	19
KPFD-3613	3C3E3A131CA	19
KPFD-3613	4CZ3A131CA	19
KPFD-3613	F81Z3A131BB	19
KPFD-3622	2SH415701	21
KPFD-3623	1C3Z3A131AB/BA	21
KPFD-3624	2C353B406AA	21
KPFD-3625	1C3Z3A131AB/BA	21
KPFD-3625	2C353B406AA	21
KPFD-3625	6C353B008BA	21
KPFD-3626	-	21
KPFD-3627	6C353B008AC	21

**FIAT**

Nº LONTRA	MODELO COMPATÍVEL	PÁG
KPF-010	1331640080	40
KPF-011	1331641080	40
KPF-020	1306716080	40
KPF-021	77362278	40
KPF-030	1903652	40
KPF-030	9380062	40
KPF-030	9945836	40

**HYUNDAI**

Nº LONTRA	MODELO COMPATÍVEL	PÁG
KPCZ-170	4914043001	39
KPH-010	5687243000	38
KPH-011	5682047500	38
KPH-012	568202E000	38
KPH-013	568202E900	38
KPH-020	544173001	38
KPH-030	545424301	38
KPH-040	565424301	38
KPH-041	577304F000	38
KPH-042	577242E00	38

**IVECO**

Nº LONTRA	MODELO COMPATÍVEL	PÁG
KPI-010	93802209	40
KPI-020	93807545	40
KPI-021	504212584	40
KPI-030	1903652	40
KPI-030	9380062	40
KPI-031	93827647	40
KPI-040	42532977	40

**KIA**

Nº LONTRA	MODELO COMPATÍVEL	PÁG
KPCZ-171	ONO1025060A	37
KPCZ-171	175725060	37
KPCZ-172	OWO1025060A	37
KPCZ-172	016425060	37
KPCZ-210	-	37
KPK-100	SOK71032240	37
KPK-105	SOK72A32240	37
KPK-110	SOK71034540	37
KPK-120	SOK71034510	37
KPK-121	SOK72A34510A	37
KPK-122	OK72A34200A	37
KPK-130	SOSA3932115	37

**LAND HOVER**

Nº LONTRA	MODELO COMPATÍVEL	PÁG
KPCZ-201	-	30
KPL-010	RTC5870	30
KPL-020	RTC-5869	30
KPL-030	NRC9742	30
KPL-040	-	30



**MERCEDEZ-BENZ**

Nº LONTRA	MODELO COMPATÍVEL	PÁG
KPCZ-210	0004101231	36
KPM-211	6313340253	35
KPM-212	9013200289	35
KPM-213	9013200389	35
KPM-700	6313300435	34
KPM-701	0013304835	34
KPM-702	6313300535	34
KPM-703	0004606548	35
KPM-704	9014600148	35
KPM-705	9013331127	35
KPM-707	9014600205	35
KPM-708	9064600348	35
KPM-709	Nº DAS BANDEJAS 9063304007	35
KPM-709	Nº DAS BANDEJAS 9063304107	35
KPM-710	9604600155	35
KPM-935	6313300603	34
KPM-936	6313300703	34
KPM-937	6314600705	34

**MITSUBISHI**

Nº LONTRA	MODELO COMPATÍVEL	PÁG
KPB-010	56872-4300	13
KPB-020	MB527350	13
KPB-030	MB525350	13
KPB-040	MB56542-4301	13
KPB-050	MB541206	13
KPB-051	MB831044	13
KPB-051	MR296274	13
KPB-060	MB176309	13
KPB-061	MB860830	13
KPB-062	MB496792	13
KPB-070	MB176308	13
KPB-071	MB831037	13
KPB-072	MB831038	14
KPB-073	MB4967799	14
KPB-075	4422A018	14
KPB-075	4442A018	14
KPB-075	MR403420	14
KPB-076	MB564991	14
KPB-076	MR548285	14
KPB-076	MR414939	14
KPB-077	4422A036	14
KPB-078	MR510267	14
KPB-079	4410A173	14
KPB-080	MB241171	14
KPB-081	MB831043	14
KPB-082	MB508136	14
KPB-083	MB508135	15
KPB-084	4422A012	15
KPB-085	MR403100	15
KPB-086	MR448255	15
KPB-090	MB592810	15
KPB-090	MB241793	15
KPB-100	MB241423	15
KPB-110	MB344654	15
KPB-120	MB592134	15
KPB-120	MB592120	15
KPB-121	MR592134	15
KPB-122	MB831042	15
KPCZ-132	MR196837	16
KPCZ-146	MR232115	16
KPCZ-299	MR196839	16
KPCZ-285	MR000267	16

**NISSAN**

Nº LONTRA	MODELO COMPATÍVEL	PÁG
KPCZ-324	4914043001	32
KPCZ-324	371255000	32
KPCZ-327	3712518025	32
KPN-001	485703S525	32
KPN-002	485203S523	32
KPN-003	D8510VK90A	32
KPN-004	485603S525	32
KPN-005	4016025601	32
KPN-006	40110VJ200	32
KPN-007	54500E870A	32
KPN-010	4853031G25	32
KPN-011	485303S525	32
KPN-011	D8530VK90A	32

**RENAULT**

Nº LONTRA	MODELO COMPATÍVEL	PÁG
KPR-001	-	41
KPR-002	7701470364	41
KPR-003	7701470363	41
KPR-004	503069	41
KPR-005	503061	41
KPR-006	-	41
KPR-007	-	41
KPR-008	7701461770	41

**VOLKSWAGEN**

Nº LONTRA	MODELO COMPATÍVEL	PÁG
KPVW-001	2HO422817	31
KPVW-002	2HO422818	31
KPVW-003	-	31
KPVW-004	2HO419804	31
KPVW-005	2HO419803	31
KPVW-008	Nº DA BANDEJA 2HO407152A	31
KPVW-009	Nº DA BANDEJA 2HO407022B	31

**TOYOTA**

Nº LONTRA	MODELO COMPATÍVEL	PÁG
KPCZ-121	040371-60010	12
KPCZ-130	040371-35056	12
KPCZ-139	040371-OK070	12
KPCZ-146	040371-36021	12
KPCZ-208	374019-8001B	12
KPCZ-208	OJOL37105	12
KPCZ-295	040371-OK080	12
KPCZ-296	040375-OK010	12
KPCZ-297	040371-AR020	12
KPCZ-297	040371-04010	12
KPCZ-298	04371-60070	12
KPCZ-298	04371-30020	12
KPT-436	45046-39285	6
KPT-437	45047-39115	6
KPT-438	45046-39385	6
KPT-439	45406-39185	6
KPT-440	45490-39365	6
KPT-441	45046-09310	6
KPT-442	45503-09340	6
KPT-443	43310-09030	6
KPT-444	43330-09490	6
KPT-445	45490-39455	6
KPT-446	45401-35270	7
KPT-447	43340-39325	7
KPT-447	43340-39465	7
KPT-448	43340-39415	7
KPT-448	43330-39585	7
KPT-449	43310-39016	7
KPT-541	43360-39085	7
KPT-543	43340-39245	7
KPT-544	45401-35240	7
KPT-545	45046-98001	7
KPT-545	OJ30L-43201	7
KPT-546	45047-98001	7
KPT-546	OJ30L-45301	7
KPT-547	45043-98001	7
KPT-547	B2BJ.45302	7
KPT-548	45430-98001	8
KPT-548	BJF20.45350	8
KPT-549	45045-98001	8
KPT-549	BRS.45303	8
KPT-550	45044-98001	8
KPT-550	BRR.45301	8
KPT-551	45422-98002	9
KPT-552	90023-84001	9
KPT-553	43431-98001	9
KPT-554	43431-98003	9
KPT-555	43431-98005	9
KPT-556	43511-98003	9
KPT-557	46501-98001	9
KPT-558	42411-98001	9
KPT-560	45046-39185R	10
KPT-561	45046-39185L	10
KPT-562	45047-39165R	11
KPT-563	45047-39165L	11
KPT-564	43350-36010	11
KPT-703	45460-98002	11
KPT-703A	45460-98002	11
KPT-706	45450-98002	11
KPT-706A	45450-98002	11
KPT-706A	45440-98002	11
KPT-709	45440-98002	11
KPT-709A	45440-98001	11

**Tecnologia a serviço do transporte**

Tecnologia a serviço do transporte



**AGRALE**

MODELO COMPATÍVEL	Nº LONTRA	PÁG
6003009007004	KPCZ-252	42
6006007016000	KPA-702	42
6006007017008	KPA-703	42
6006007132005	KPA-710	42
6006007133003	KPA-711	42
6006009009003	KPCZ-266	42
6006069009003	KPCZ-210	42
6007007331001	KPA-702	42
6007007331001	KPA-781	42
6007009321000	KPCZ-177	42
6007009321000	KPCZ-254	42
6008007716001	KPA-782	42

**CHEVROLET**

MODELO COMPATÍVEL	Nº LONTRA	PÁG
-	KPG-4040	26
3767052	KPG-6020	28
3817956	KPG-6010	28
3826596	KPG-3117	25
3986724	KPG-3251	25
7317470	KPG-3117	25
7323877	KPG-080	27
7323878	KPG-167	27
7324559	KPG-1050	26
7330710	KPG-080	27
7352431	KPCZ-121	29
7364605	KPCZ-121	29
7634605	KPCZ-210	29
9297512	KPG-1049	26
9297513	KPG-1049	26
9297514	KPG-3118	25
9297515	KPG-3117	25
9304148	KPG-167	27
26033088	KPG-4037	25
26033089	KPG-4036	25
26046110CG	KPG-6000	28
26046110CP	KPG-6001	28
52252914	KPG-3252	25
52256814	KPG-6027	28
52258111	KPG-080	27
52258112	KPG-167	27
52286801	KPG-3249	26
52286801	KPG-3250	26
92328935	KPG-848	27
93213067	KPG-707	27
93213068	KPG-703	27
93230827	KPG-848	27
93281740	KPG-848	27
93292476	KPG-867	27
93314316	KPG-875	27
93328935	KPG-875	27
93331416	KPG-870	27
93331496	KPG-875	27
93360627	KPG-6029	28
94622086	KPCZ-121	29
94630474	KPG-703	27
94630475	KPG-707	27
94634078	KPG-6022	28
94634079	KPG-6021	28
94644439	KPG-8007	28
94644440	KPG-8008	28
94648487	KPG-3251	25
94651679	KPG-6023	28
94727113	KPG-900	27
94727114	KPG-901	27
94772911	KPG-4041	26
94772911	KPG-4045	25
522700196	KPCZ-256	29

**DODGE**

MODELO COMPATÍVEL	Nº LONTRA	PÁG
-	KPD-1000	33
-	KPD-1001	33
-	KPD-1002	33
-	KPD-1003	33
-	KPD-2300	33
-	KPD-2301	33
-	KPD-2302	33
-	KPD-3300	33
-	KPD-3301	33
52122362AE	KPD-3302	33

**FORD**

MODELO COMPATÍVEL	Nº LONTRA	PÁG
-	KPCZ-291	24
-	KPCZ-292	24
-	KPFD-0980	18
-	KPFD-3377	21
-	KPFD-3378	21
-	KPFD-3626	21
1C3Z3A131BA	KPFD-3612	19
1C3Z3A131AB/BA	KPFD-3623	21
1C3Z3A131AB/BA	KPFD-3625	21
1C3Z3A1321AB	KPFD-3613	19
2C353289BA	KPFD-3382	18
2C353290BA	KPFD-3383	18
2C353B0008BA	KPFD-3379	21
2C353B406AA	KPFD-3410	19
2C353B406AA	KPFD-3624	21
2C353B406AA	KPFD-3625	21
2C353B406BA	KPFD-3380	18
2C353B407BA	KPFD-3381	18
2L5Z3082AA	KPFD-0743	22
2L5Z3083AA	KPFD-0742	22
2SH415701	KPFD-3622	21
3C3E3A131CA	KPFD-3613	19
4CZ3A131CA	KPFD-3613	19
5L553395AA	KPFD-0741	22
6C11/3289AC	KPFD-0988	18
6C353B0008AC	KPFD-3627	21
6C353B0008BA	KPFD-3625	21
6CL3L519AA	KPFD-0987	18
6CL3L519BA	KPFD-0987	18
79TU3304A	KPFD-2303	20
83PU4758A	KPCZ-120	24
85TU3280	KPFD-726	20
85TU3280B	KPFD-726	20
85TU3289B	KPFD-218	17
85TU3290B	KPFD-219	17
86D7039A	KPCZ-121	24
86TU3280EB	KPFD-223	20
86TU3289CA	KPFD-225	17
86TU3290CA	KPFD-224	17
86TU3304GB	KPFD-3115	20
A838	KPFD-230	17
A847	KPFD-229	17
AB313280AB	KPFD-0986	18
AB313289BA	KPFD-0985	18
AB313290BA	KPFD-0984	18
ACOT7039A	KPCZ-210	24
B11399	KPFD-228	17
BCOC7039A	KPCZ-121	24
BD2Y47039A	KPCZ-252	24
BE2C3304A	KPFD-2303	20
BE2C7039A	KPCZ-121	24
BF2C3280A	KPFD-3373	20
BF2C3289C	KPFD-3399	19
BF2C3290C	KPFD-3400	19
BF2C3304A	KPFD-3374	20
BF2C3290B	KPFD-3409	19
BF2C3289B	KPFD-3406	19
BF873049A	KPFD-0750	23
BF873049AI	KPFD-0749	23
BF873049A5	KPFD-0748	23
C5TA3A131A	KPFD-0971	17
C5TZ3280A	KPFD-0971B	20
C7TZ3280B	KPFD-215	20
C7TZ3280H	KPFD-215	20
C7TZ3304GC	KPFD-2056	20
C7TZ3A130A	KPFD-218	17
C7TZ3A131A	KPFD-219	17
C7TA3280H	KPFD-726	20
CD4D7039A	KPCZ-121	24
DB393084BA	KPFD-0746	23
Nº DA BANDEJA SUPERIOR		
DB393091BA	KPFD-0745	22
Nº DA BANDEJA INFERIOR		
E3TZZ3050AA	KPFD-0740	22
E7TA3B102AA	KPFD-0735	22
E7TA3B102DA	KPFD-0736	22
E7TZZ3049A	KPFD-0735	22
F2TZ3304C	KPFD-3376	20
F2TZ3A130E	KPFD-0977	17
F2TZ3A131C	KPFD-0975	17
F2TZ3A131F	KPFD-0976	17
F5TZ3280AA	KPFD-0979	18
F5TZ3083A	KPFD-0742	22
F5UZ3049A	KPFD-0737	22
F6TZ3050FB	KPFD-0739	22
F813304AA	KPFD-3411	19

**FORD**

MODELO COMPATÍVEL	Nº LONTRA	PÁG
F81Z3A131BB	KPFD-3613	19
F87A3084CA	KPFD-0743	22
F87Z3A130BA	KPFD-0978	18
T72415701	KPFD-3495	21
TNK407301	KPFD-0738	22
TNK407303	KPFD-0737	22
UC2M3224XA	KPFD-0986	18
UC2N32280	KPFD-0985	18
UC2N32290	KPFD-0984	18
YC153468AF	KPFD-0747	23
Z8TU3289A	KPFD-0972	17

**FIAT**

MODELO COMPATÍVEL	Nº LONTRA	PÁG
1903652	KPF-030	40
77362278	KPF-021	40
9380062	KPF-030	40
9945836	KPF-030	40
1306716080	KPF-020	40
1331640080	KPF-010	40
1331641080	KPF-011	40

**HYUNDAI**

MODELO COMPATÍVEL	Nº LONTRA	PÁG
568202E000	KPH-012	38
568202E900	KPH-013	38
577242E00	KPH-042	38
577304F000	KPH-041	38
544173001	KPH-020	38
545424301	KPH-030	38
565424301	KPH-040	38
5682047500	KPH-011	38
5687243000	KPH-010	38
4914043001	KPCZ-170	39

**IVECO**

MODELO COMPATÍVEL	Nº LONTRA	PÁG
1903652	KPI-030	40
9380062	KPI-030	40
42532977	KPI-040	40
93802209	KPI-010	40
93807545	KPI-020	40
93827647	KPI-031	40
504212584	KPI-021	40

**KIA**

MODELO COMPATÍVEL	Nº LONTRA	PÁG
-	KPCZ-210	37
016425060	KPCZ-172	37
175725060	KPCZ-171	37
OK72A34200A	KPK-122	37
ONO1025060A	KPCZ-171	37
OWO1025060A	KPCZ-172	37
S0K71032240	KPK-100	37
S0K71034510	KPK-120	37
S0K71034540	KPK-110	37
S0K72A32240	KPK-105	37
S0K72A34510A	KPK-121	37
S0SA3932115	KPK-130	37

**LAND HOVER**

MODELO COMPATÍVEL	Nº LONTRA	PÁG
-	KPCZ-201	30
-	KPL-040	30
NRC9742	KPL-030	30
RTC-5869	KPL-020	30
RTC5870	KPL-010	30

**MERCEDEZ-BENZ**

MODELO COMPATÍVEL	Nº LONTRA	PÁG
0004101231	KPCZ-210	36
0004606548	KPM-703	35
0013304835	KPM-701	34
6313300435	KPM-700	34
6313300535	KPM-702	34
6313300603	KPM-935	34
6313300703	KPM-936	34
6313340253	KPM-211	35
6314600705	KPM-937	34
9013200289	KPM-212	35
9013200389	KPM-213	35
9013331127	KPM-705	35
9014600148	KPM-704	35
9014600205	KPM-707	35
9063304007	KPM-709	35
(Nº DA BANDEJA)		
9063304107	KPM-709	35
(Nº DA BANDEJA)		
9064600348	KPM-708	35
9604600155	KPM-710	35

**MITSUBISHI**

MODELO COMPATÍVEL	Nº LONTRA	PÁG
4410A173	KPB-079	14
4422A012	KPB-084	15
4422A018	KPB-075	14
4422A036	KPB-077	14
4442A018	KPB-075	14
56872-4300	KPB-010	13
MB176308	KPB-070	13
MB176309	KPB-060	13
MB241171	KPB-080	14
MB241423	KPB-100	15
MB241793	KPB-090	15
MB344654	KPB-110	15
MB4967799	KPB-073	14
MB496792	KPB-062	13
MB508135	KPB-083	15
MB508136	KPB-082	14
MB525350	KPB-030	13
MB527350	KPB-020	13
MB541206	KPB-050	13
MB564991	KPB-076	14
MB56542-4301	KPB-040	13
MB592120	KPB-120	15
MB592134	KPB-120	15
MB592810	KPB-090	15
MB831037	KPB-071	13
MB831038	KPB-072	14
MB831042	KPB-122	15
MB831043	KPB-081	14
MB831044	KPB-051	13
MB860830	KPB-061	13
MR000267	KPCZ-285	16
MR196837	KPCZ-132	16
MR196839	KPCZ-299	16
MR232115	KPCZ-146	16
MR296274	KPB-051	13
MR403100	KPB-085	15
MR403420	KPB-075	14
MR414939	KPB-076	14
MR448255	KPB-086	15
MR510267	KPB-078	14
MR548285	KPB-076	14
MR592134	KPB-121	15

**NISSAN**

MODELO COMPATÍVEL	Nº LONTRA	PÁG
371255000	KPCZ-324	32
3712518025	KPCZ-327	32
40110VJ200	KPN-006	32
4016025601	KPN-005	32
485203S523	KPN-002	32
4853031G25	KPN-010	32
485303S525	KPN-011	32
485603S525	KPN-004	32
485703S525	KPN-001	32
4914043001	KPCZ-324	32
54500E870A	KPN-007	32
D8510VK90A	KPN-003	32
D8530VK90A	KPN-011	32

**RENAULT**

MODELO COMPATÍVEL	Nº LONTRA	PÁG
-	KPR-001	41
-	KPR-006	41
-	KPR-007	41
503061	KPR-005	41
503069	KPR-004	41
7701461770	KPR-008	41
7701470363	KPR-003	41
7701470364	KPR-002	41

**VOLKSWAGEN**

MODELO COMPATÍVEL	Nº LONTRA	PÁG
-	KPVW-003	31
2HO407022B	KPVW-009	31
(Nº DA BANDEJA)		
2HO407152A	KPVW-008	31
(Nº DA BANDEJA)		
2HO419803	KPVW-005	31
2HO419804	KPVW-004	31
2HO422817	KPVW-001	31
2HO422818	KPVW-002	31

**TOYOTA**

MODELO COMPATÍVEL	Nº LONTRA	PÁG
040371-04010	KPCZ-297	12
040371-35056	KPCZ-130	12
040371-36021	KPCZ-146	12
040371-60010	KPCZ-121	12
040371-AR020	KPCZ-297	12
040371-OK070	KPCZ-139	12
040371-OK080	KPCZ-295	12
040375-OK010	KPCZ-296	12
04371-30020	KPCZ-298	12
04371-60070	KPCZ-298	12
374019-8001B	KPCZ-208	12
42411-98001	KPT-558	9
43310-09030	KPT-443	6
43310-39016	KPT-449	7
43330-09490	KPT-444	6
43330-39585	KPT-448	7
43340-39245	KPT-543	7
43340-39325	KPT-447	7
43340-39415	KPT-448	7
43340-39465	KPT-447	7
43350-36010	KPT-564	11
43360-39085	KPT-541	7
43431-98001	KPT-553	9
43431-98003	KPT-554	9
43431-98005	KPT-555	9
43511-98003	KPT-556	9
45043-98001	KPT-547	7
45044-98001	KPT-550	8
45045-98001	KPT-549	8
45046-09310	KPT-441	6
45046-39185L	KPT-561	10
45046-39185R	KPT-560	10
45046-39285	KPT-436	6
45046-39385	KPT-438	6
45046-98001	KPT-545	7
45047-39115	KPT-437	6
45047-39165L	KPT-563	11
45047-39165R	KPT-562	11
45047-98001	KPT-546	7
45401-35240	KPT-544	7
45401-35270	KPT-446	7
45406-39185	KPT-439	6
45422-98002	KPT-551	9
45430-98001	KPT-548	8
45440-98001	KPT-709A	11
45440-98002	KPT-706A	11
45440-98002	KPT-709	11
45450-98002	KPT-706	11
45450-98002	KPT-706A	11
45460-98002	KPT-703	11
45460-98002	KPT-703A	11
45490-39365	KPT-440	6
45490-39455	KPT-445	6
45503-09340	KPT-442	6
46501-98001	KPT-557	9
90023-84001	KPT-552	9
B2BJ.45302	KPT-547	7
BJF20.45350	KPT-548	8
BRR.45301	KPT-550	8
BRS.45303	KPT-549	8
OJ30L.43201	KPT-545	7
OJ30L.45301	KPT-546	7
OJOL.37105	KPCZ-208	12

**Tecnologia a serviço do transporte**

Tecnologia a serviço do transporte





FIGURA	Nº Lontra	Modelos Compatíveis	Rosca	Descrição e Aplicação
<b>A:83mm</b> <b>B:M21x1,5</b> 	<b>KPT-436</b> 1.X-X-X 2.X-X-X 3.X-X-X	45046-39285	Esquerda	Terminal de Direção Curto Hilux 4x2 até 97
<b>A:215mm</b> <b>B:M21x1,5</b> 	<b>KPT-437</b> 1.X-X-X 2.X-X-X 3.X-X-X	45047-39115	Direita	Terminal de Direção Longo Hilux 4x2 até 97
<b>A:88mm</b> <b>B:M17x1,5</b> 	<b>KPT-438</b> 1.X-X-X 2.X-X-X 3.X-X-X	45046-39385	Esquerda	Terminal de Direção Curto Hilux 4x4 de 97 em diante
<b>A:200mm</b> <b>B:M17x1,5</b> 	<b>KPT-439</b> 1.X-X-X 2.X-X-X 3.X-X-X	45406-39185	Direita	Terminal de Direção Longo Hilux 4x4 até 97
	<b>KPT-440</b> 1.X-X-X 2.X-X-X 3.X-X-X	45490-39365		Braço Auxiliar Hilux 4x4 de 1997 a 2005
<b>A:87mm</b> <b>B:50mm</b> <b>F:M15x1,5</b> 	<b>KPT-441</b> 1.X-X-X 2.X-X-X 3.X-X-X	45046-09310	Direita	Terminal de Direção Curto Hilux 4x4 2005 em diante
	<b>KPT-442</b> 1.X-X-X 2.X-X-X 3.X-X-X	45503-09340	Direita	Haste Axial Hilux 4x4 2005 em diante
	<b>KPT-443</b> 1.X-X-X 2.X-X-X 3.X-X-X	43310-09030		Pivot Superior Hilux 4x4 2005 em diante
	<b>KPT-444</b> 1.X-X-X 2.X-X-X 3.X-X-X	43330-09490		Pivot Inferior Hilux 4x4 2005 em diante
	<b>KPT-445</b> 1.X-X-X 2.X-X-X 3.X-X-X	45490-39455		Braço Auxiliar Hilux 4x4 2005 em diante

## Tecnologia a serviço do transporte













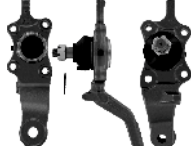

FIGURA	Nº Lontra	Modelos Compatíveis	Rosca	Descrição e Aplicação
	<b>KPT-446</b> 1.X-X-X 2.X-X-X 3.X-X-X	45401-35270		Braço Pitman Hilux 4x4 2005 em diante
	<b>KPT-447</b> 1.X-X-X 2.X-X-X 3.X-X-X	43340-39325 43340-39465		Pivot Inferior Direito Hilux SW4 de 1995 em diante Prado de 2003 em diante
	<b>KPT-448</b> 1.X-X-X 2.X-X-X 3.X-X-X	43340-39415 43330-39585		Pivot Inferior Esquerdo Hilux SW4 de 1995 em diante Prado de 2003 em diante
	<b>KPT-449</b> 1.X-X-X 2.X-X-X 3.X-X-X	43310-39016		Pivot Superior Hilux SW4 de 1995 em diante Prado de 2003 em diante
	<b>KPT-541</b> 1.X-X-X 2.X-X-X 3.X-X-X	43360-39085	Superior	Pivot Superior Hilux 4x4 de 1997 a 2005
	<b>KPT-543</b> 1.X-X-X 2.X-X-X 3.X-X-X	43340-39245	Inferior	Pivot Inferior Hilux 4x4 de 1997 a 2005
	<b>KPT-544</b> 1.X-X-X 2.X-X-X 3.X-X-X	45401-35240		Braço Pitman Hilux 4x4 de 1997 a 2005
<b>A:145mm</b> <b>B:M20x1,5</b> 	<b>KPT-545</b> 1.X-X-X 2.PD2000 3.N760	45046-98001 OJ30L.43201	Esquerda	Bandeirantes
<b>A:80mm</b> <b>B:M20x1,5</b> 	<b>KPT-546</b> 1.X-X-X 2.PD1999 3.N758	45047-98001 OJ30L.45301	Direita	Bandeirantes
<b>A:80mm</b> <b>B:M17x1,5</b> 	<b>KPT-547</b> 1.X-X-X 2.PD1996 3.N756	45043-98001 B2BJ.45302	Esquerda	Bandeirantes

FIGURA	Nº Lontra	Modelos Compatíveis	Rosca	Descrição e Aplicação
<b>A:168mm</b> <b>B:M17x1,5</b> 	<b>KPT-548</b> 1.X-X-X 2.PD2275 3.X-X-X	45430-98001 BJJ20.45350	Direita	Bandeirantes
<b>A:78mm</b> <b>B:M17x1,5</b> 	<b>KPT-549</b> 1.X-X-X 2.PD1997 3.N759	45045-98001 BRS 45303	Esquerda	Bandeirantes
<b>A:78mm</b> <b>B:M17x1,5</b> 	<b>KPT-550</b> 1.X-X-X 2.PD1998 3.N757	45044-98001 BRR 45301	Direita	Bandeirantes











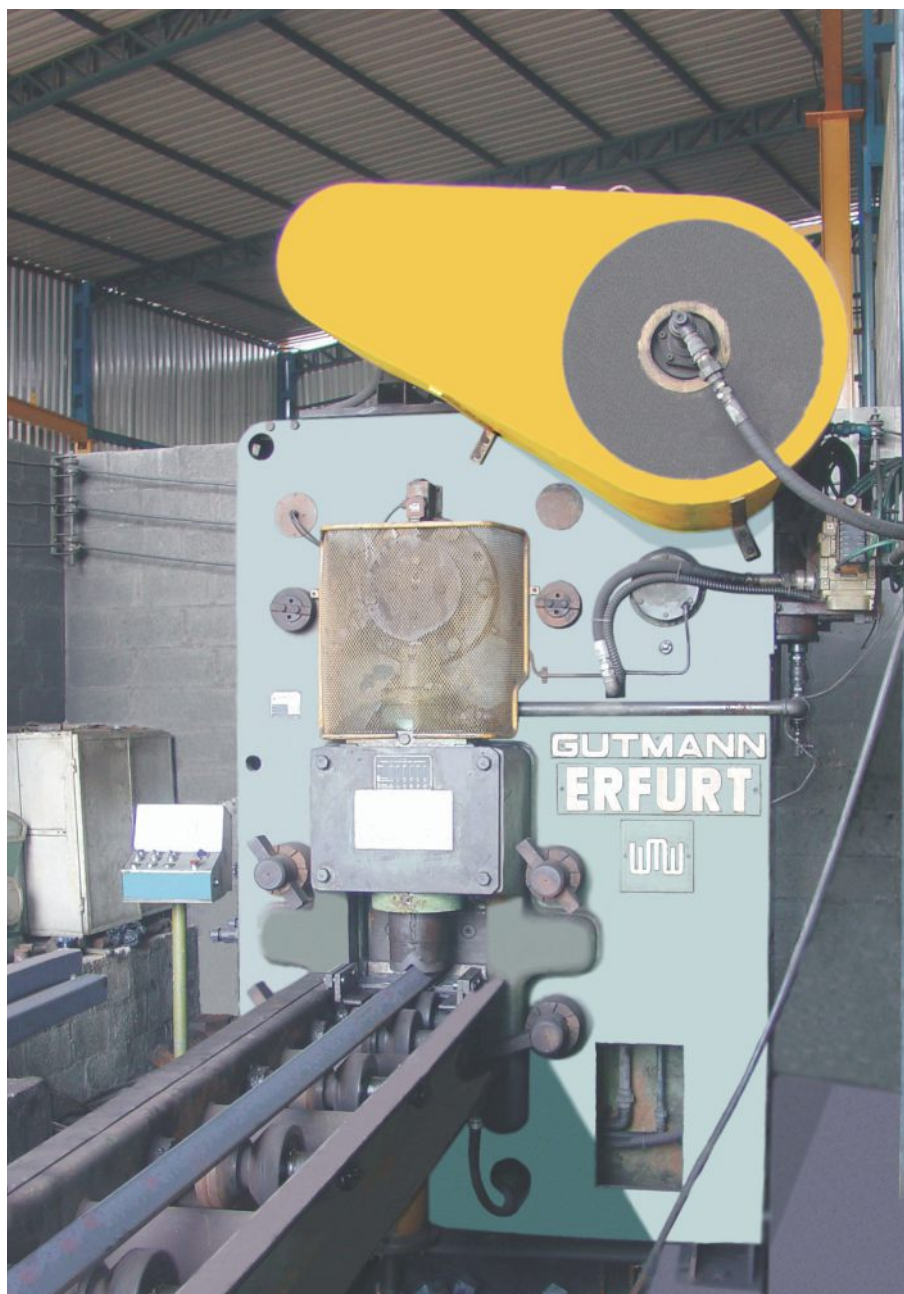

FIGURA	Nº Lontra	Modelos Compatíveis	Descrição e Aplicação
	<b>KPT-551</b>	45422-98002	Bandeirantes Pino Cônico Central
	<b>KPT-552</b>	90023-84001	Bandeirantes Bucha Cônica Central
	<b>KPT-553</b>	43431-98001	Bandeirantes Manga Furo 8m/m
	<b>KPT-554</b>	43431-98003	Bandeirantes Manga Furo 10m/m
	<b>KPT-555</b>	43431-98005	Bandeirantes Manga Moderna Furo 10m/m
	<b>KPT-556</b>	43511-98003	Bandeirantes Cubo de Roda Dianteiro
	<b>KPT-557</b>	46501-98001	Bandeirantes Tambor do Freio de Mão
	<b>KPT-558</b>	42411-98001	Bandeirantes Cubo de Roda Traseiro

FIGURA	Nº Lontra	Modelos Compatíveis	Rosca	Descrição e Aplicação
<b>A:98mm</b> <b>B:M21x1,5</b> 	<b>KPT-560</b> 1.X-X-X 2.X-X-X 3.X-X-X	45046-39185R	Direita	Coaster
<b>A:98mm</b> <b>B:M21x1,5</b> 	<b>KPT-561</b> 1.X-X-X 2.X-X-X 3.X-X-X	45046-39185L	Esquerda	Coaster



**Tecnologia a serviço do transporte**





















FIGURA	Nº Lontra	Modelos Compatíveis	Rosca	Descrição e Aplicação
<b>A:295mm</b> <b>B:M21x1,5</b> 	<b>KPT-562</b> 1.X-X-X 2.X-X-X 3.X-X-X	45047-39165R	Direita	Coaster
<b>A:295mm</b> <b>B:M21x1,5</b> 	<b>KPT-563</b> 1.X-X-X 2.X-X-X 3.X-X-X	45047-39165L	Esquerda	Coaster
	<b>KPT-564</b> 1.X-X-X 2.X-X-X 3.X-X-X	43350-36010	Pivot	Coaster
KPT545  COMPRIMENTO G:1300mm	<b>KPT-703</b> 1.X-X-X 2.BD1992 3.X-X-X	45460-98002	-	Bandeirantes após 5/83
 COMPRIMENTO:1048mm	<b>KPT-703A</b> 1.X-X-X 2.BD3485 3.X-X-X	45460-98002	-	Só Barra sem Terminais Bandeirantes após 5/83
KPT550  COMPRIMENTO G:836mm	<b>KPT-706</b> 1.X-X-X 2.BD3491 3.X-X-X	45450-98002	-	Bandeirantes após 5/83
 COMPRIMENTO:736mm	<b>KPT-706A</b> 1.X-X-X 2.BD3491 3.X-X-X	45450-98002 45440-98002	-	Só Barra sem Terminais Bandeirantes após 5/83
KPT548  COMPRIMENTO G:736mm	<b>KPT-709</b> 1.X-X-X 2.X-X-X 3.X-X-X	45440-98002	-	Bandeirantes após 5/83
 COMPRIMENTO:710mm	<b>KPT-709A</b> 1.X-X-X 2.X-X-X 3.X-X-X	45440-98001	-	Só Barra sem Terminais Bandeirantes após 5/83

FIGURA	Nº Lontra	Modelos Compatíveis	Descrição e Aplicação
	<b>KPCZ-121</b> SPI.:5153 ST.:CZ121 MP.:CR1001	040371-60010	Cruzeta do Cardan Hilux de 1997 a 2000
	<b>KPCZ-130</b> SPI.:X-X-X ST.:X-X-X- MP.:X-X-X	040371-35056	Cardan Dianteiro e Traseiro Hilux de 1997 a 2000 1ª Série
	<b>KPCZ-139</b> SPI.:X-X-X ST.:X-X-X- MP.:X-X-X	040371-OK070	Cardan Traseiro SW4 de 2005 em diante
	<b>KPCZ-146</b> SPI.:X-X-X ST.:X-X-X- MP.:X-X-X	040371-36021	Cardan Traseiro Hilux de 2004 em diante
	<b>KPCZ-208</b> SPI.:5178X ST.:CZ208 MP.:CR1501	374019-8001B OJOL37105	Cardan Dianteiro e Traseiro Bandeirantes
	<b>KPCZ-295</b> SPI.:X-X-X ST.:CZ295 MP.:X-X-X	040371-OK080	Cardan Traseiro Hilux de 2005 em diante
	<b>KPCZ-296</b> SPI.:X-X-X ST.:CZ296 MP.:X-X-X	040375-OK010	Cardan Dianteiro e Traseiro Hilux de 2005 em diante SW4 de 2005 em diante
	<b>KPCZ-297</b> SPI.:5113X ST.:CZ297 MP.:X-X-X	040371-AR020 040371-04010	Trava Externa Cardan Traseiro Hilux de 1997 a 2004
	<b>KPCZ-298</b> SPI.:X-X-X ST.:CZ298 MP.:X-X-X	04371-60070 04371-30020	Cardan Traseiro Hilux de 1997 a 2004

**Tecnologia a serviço do transporte**





FIGURA	Nº Lontra	Modelos Compatíveis	Rosca	Descrição e Aplicação
<b>A:76mm</b> <b>D:40mm</b> <b>F:M14x1,5</b> 	<b>KPB-010</b> 1.X-X-X 2.X-X-X 3.X-X-X	56872-4300	Direita Interna	Terminal de Direção L300
	<b>KPB-020</b> 1.X-X-X 2.X-X-X 3.X-X-X	MB527350	Pivot	Pivot Superior L300
	<b>KPB-030</b> 1.X-X-X 2.X-X-X 3.X-X-X	MB525350	Pivot	Pivot Inferior L300
<b>B:M14x1,5</b> <b>C:M14x1,5</b> <b>E:310mm</b> 	<b>KPB-040</b> 1.X-X-X 2.X-X-X 3.X-X-X	MB56542-4301	Direita	Barra de Direção L300
<b>A:160mm</b> <b>B:M16x1,5</b> 	<b>KPB-050</b> 1.X-X-X 2.X-X-X 3.X-X-X	MB541206	Direita	Terminal de Direção Longo (Curvo) - L200 GL/GLS 4x4
<b>A:160mm</b> <b>B:M16x1,5</b> 	<b>KPB-051</b> 1.X-X-X 2.X-X-X 3.X-X-X	MB831044 MR296274	Direita	Terminal de Direção Longo (Curvo) L200 Sport/HPE/Outdoor/Pajeto Sport TDS/Pajero Full .../99
	<b>KPB-060</b> 1.X-X-X 2.X-X-X 3.X-X-X	MB176309	Superior	Pivot Superior L200 GL/GLS 4x4
	<b>KPB-061</b> 1.X-X-X 2.X-X-X 3.X-X-X	MB860830	Superior	Pivot Superior L200 Sport/HPE/Outdoor/Pajeto Sport TDS/Pajero Full .../99
	<b>KPB-062</b> 1.X-X-X 2.X-X-X 3.X-X-X	MB496792	Superior	Pivot Superior Triton TDS MDS/Dakar TDS/Pajero Full 01/...
	<b>KPB-070</b> 1.X-X-X 2.X-X-X 3.X-X-X	MB176308	Inferior	Pivot Inferior L200 GL/GLS 4x4
	<b>KPB-071</b> 1.X-X-X 2.X-X-X 3.X-X-X	MB831037	Esquerda	Pivot Inferior L200 Sport/HPE/Outdoor/Pajeto Sport TDS/Pajero Full .../99

FIGURA	Nº Lontra	Modelos Compatíveis	Rosca	Descrição e Aplicação
	<b>KPB-072</b> 1.X-X-X 2.X-X-X 3.X-X-X	MB831038	Direita	Pivot Inferior L200 Sport/HPE/Outdoor/ Pajeto Sport TDS/Pajero Full .../99
	<b>KPB-073</b> 1.X-X-X 2.X-X-X 3.X-X-X	MB4967799		Pivot Inferior Triton TDS MDS/Dakar TDS/ Pajero Full 01/...
 A:75,00mm D:40,00 F:M14x1,5	<b>KPB-075</b> 1.X-X-X 2.X-X-X 3.X-X-X	4422A018 4442A018 MR403420	Direita	Terminal de Direção ASX de 2010 em diante LANCER 2008 em diante Outlander 4x4 de 2006 em diante Outlander 4x2 de 2007 em diante
 A:75,00mm D:40,00 F:M14x1,5	<b>KPB-076</b> 1.X-X-X 2.X-X-X 3.X-X-X	MB564991 MR548285 MR414939	Direita	Terminal de Direção AIRTREK - 2003 / 2008 EXPO 1992 a 1996 Outlander de 2003 em diante Pajero IO 1999 / 2002 TR4 de 2003 em diante
 B:M16x1,5 E:190mm C:M16x1,5	<b>KPB-077</b> 1.X-X-X 2.X-X-X 3.X-X-X	4422A036	Direita	Barra Axial Pajero Full 2007 em diante Barra Axial
 B:M16x1,5 E:206mm C:M16x1,5	<b>KPB-078</b> 1.X-X-X 2.X-X-X 3.X-X-X	MR510267	Direita	Barra Axial Pajero Full 2001 a 2007
 B:M16x1,5 E:200mm C:M16x1,5	<b>KPB-079</b> 1.X-X-X 2.X-X-X 3.X-X-X	4410A173	Direita	Barra Axial L200 Triton de 2008 em diante
 A:90mm B:M16x1,5	<b>KPB-080</b> 1.X-X-X 2.X-X-X 3.X-X-X	MB241171	Esquerda	Terminal de Direção Curto (Reto) L200 GL / GLS 4x4
 A:110mm B:M16x1,5	<b>KPB-081</b> 1.X-X-X 2.X-X-X 3.X-X-X	MB831043	Esquerda	Terminal de Direção Curto (Reto) L200 Sport/HPE/Outdoor/ Pajero Sport TDS/Pajero Full .../99
 A:185mm F:M16x1,5 D:50mm	<b>KPB-082</b> 1.X-X-X 2.X-X-X 3.X-X-X	MB508136	Direita	Terminal de Direção Triton TDS MDS/Dakar TDS/ Pajero Full 01/...



FIGURA	Nº Lontra	Modelos Compatíveis	Rosca	Descrição e Aplicação
<b>A:185mm F:M16x1,5</b> <b>D:50mm</b> 	<b>KPB-083</b> 1.X-X-X 2.X-X-X 3.X-X-X	MB508135	Direita	Terminal de Direção Triton TDS MDS/Dakar TDS/ Pajero Full 01/...
<b>B:M14x1,5 E:342mm</b> <b>C:M14x1,5</b> 	<b>KPB-084</b> 1.X-X-X 2.X-X-X 3.X-X-X	4422A012	Direita	Barra Axial ASX 2010 em diante Lancer 2008 em diante Outlander 4X4 e 4X2 2006 em diante
<b>B:M14x1,5 E:320mm</b> <b>C:M16x1,5</b> 	<b>KPB-085</b> 1.X-X-X 2.X-X-X 3.X-X-X	MR 403100	Direita	Barra Axial Airtrek 2002 a 2008
<b>B:M14x1,5 E:345mm</b> <b>C:M16x1,5</b> 	<b>KPB-086</b> 1.X-X-X 2.X-X-X 3.X-X-X	MR 44 8255	Direita	Barra Axial Pajero i0 1998 a 2002 Pajero TR4 2003 em diante
	<b>KPB-090</b> 1.X-X-X 2.X-X-X 3.X-X-X	Mb592810 MB241793		Braço Pitman L200 GL / GLS 4x4
	<b>KPB-100</b> 1.X-X-X 2.X-X-X 3.X-X-X	MB241423		Braço Auxiliar L200 Sport/HPE/Outdoor/ Pajero Sport TDS
	<b>KPB-110</b> 1.X-X-X 2.X-X-X 3.X-X-X	MB344654		Braço Auxiliar L200 Sport/HPE/Outdoor/ Pajero Sport TDS
	<b>KPB-120</b> 1.X-X-X 2.X-X-X 3.X-X-X	MB592134 MB592120		Braço Pitman L200 GL / GLS 4x4
	<b>KPB-121</b> 1.X-X-X 2.X-X-X 3.X-X-X	MR592134		Braço Pitman Pajero 2.8 - 3.0 - 3.5 até 1999
	<b>KPB-122</b> 1.X-X-X 2.X-X-X 3.X-X-X	MB831042		Braço Auxiliar Pajero 2.8 - 3.0 - 3.5 até 1999

## Tecnologia a serviço do transporte

FIGURA	Nº Lontra	Modelos Compatíveis	Descrição e Aplicação
	<b>KPCZ-132</b> SPI.:X-X-X ST.:X-X-X- MP.:X-X-X	MR196837	Cardan Dianteiro L200
	<b>KPCZ-146</b> SPI.:X-X-X ST.:X-X-X- MP.:X-X-X	MR232115	Cardan Dianteiro e Traseiro L200 Sport
	<b>KPCZ-299</b> SPI.:X-X-X ST.:CZ299 MP.:X-X-X	MR196839	Cardan Traseiro L200
	<b>KPCZ-285</b> SPI.:X-X-X ST.:X-X-X MP.:X-X-X	MR000267	Trava Interna



## Tecnologia a serviço do transporte













FIGURA	Nº Lontra	Modelos Compatíveis	Rosca	Descrição e Aplicação
<b>A:136mm</b> <b>B:1"x18</b> 	<b>KPFD-218</b> 1.X-X-X 2.PD2184 3.N218	C7TZ 3A130A 85TU 3289B	Direita	Lateral F350 - 400 de 1971 a 1986 F2000 - 4000 até 12/1986
<b>A:460mm</b> <b>B:1"x18</b> 	<b>KPFD-219</b> 1.X-X-X 2.PD2185 3.N219	C7TZ 3A131A 85TU 3290B	Esquerda	Lateral F350 - 400 de 1971 a 1986 F2000 - 4000 até 12/1986
<b>A:480mm</b> <b>B:1"x18</b> 	<b>KPFD-224</b> 1.X-X-X 2.PD3185 3.N224	86TU 3290CA	Esquerda	F2000 - 4000 de 12/1986 a 1999
<b>A:136mm</b> <b>B:1"x18</b> 	<b>KPFD-225</b> 1.X-X-X 2.PD3184 3.N225	86TU 3289CA	Direita	F2000 - 4000 de 12/1986 a 1999
<b>A:216mm</b> <b>B:1 1/16"x18</b> 	<b>KPFD-228</b> 1.X-X-X 2.PD0360 3.X-X-X	B 11.399	Esquerda	Jeep   Rural   Willys
<b>A:78mm</b> <b>B:1 1/16"x18</b> 	<b>KPFD-229</b> 1.X-X-X 2.PD3811 3.X-X-X	A 847	Esquerda	Jeep   Rural   Willys
<b>A:78mm</b> <b>B:1 1/16"x18</b> 	<b>KPFD-230</b> 1.X-X-X 2.PD3812 3.X-X-X	A 838	Direita	Jeep   Rural   Willys
<b>A:440mm</b> <b>B:7/8"x18</b> 	<b>KPFD-0971</b> 1.X-X-X 2.PD0951 3.N244	C5TA 3A131A	Esquerda	Terminal de Direção F1000 - 1000 de 1968 a 1991
<b>A:102mm</b> <b>B:7/8"x18</b> 	<b>KPFD-0972</b> 1.TS972R 2.PD0955 3.N243	Z8TU 3289A	Direita	Terminal de Direção F1000 - 1000 de 1968 a 1991
<b>A:136mm</b> <b>B:M20x1,5</b> 	<b>KPFD-0975</b> 1.X-X-X 2.X-X-X 3.X-X-X	F2TZ 3A131C	Esquerda	Terminal Ranger 4x2 4x4 até 1997
<b>A:136mm</b> <b>B:M22x1,5</b> 	<b>KPFD-0976</b> 1.X-X-X 2.X-X-X 3.X-X-X	F2TZ3A131F	Direita	Terminal Ranger 4x2 4x4 até 1997
<b>A:380mm</b> <b>B:M20x1,5</b> 	<b>KPFD-0977</b> 1.X-X-X 2.X-X-X 3.X-X-X	F2TZ 3A130E	Direita	Terminal Longo Ranger 4x2 4x4 até 1997

FIGURA	Nº Lontra	Modelos Compatíveis	Rosca	Descrição e Aplicação
<b>A:119mm</b> <b>D:60mm</b> <b>F:M14x1,5</b> 	<b>KPFD-0978</b> 1.X-X-X 2.X-X-X 3.X-X-X	F87Z 3A130BA	Direita	Terminal Ranger 4x2 4x4 de 1998 até 2012
<b>B:M14x1,5</b> <b>E:260mm</b> <b>C:M16x1,5</b> 	<b>KPFD-0979</b> 1.X-X-X 2.X-X-X 3.X-X-X	F57Z 3280AA	Direita	Barra Axial Ranger 4x2 4x4 de 1998 até 2012
	<b>KPFD-0980</b> 1.X-X-X 2.X-X-X 3.X-X-X	-	-	Conjunto de Barra e Terminal Ranger 4x2 4x4 de 1998 até 2012
<b>A:200mm</b> <b>D:55mm</b> <b>F:M14x1,5</b> 	<b>KPFD-0984</b> 1.X-X-X 2.X-X-X 3.X-X-X	UC2N32290 AB313290BA	Direita	Terminal Esquerdo Ranger 4x2 4x4 após 2012
<b>A:200mm</b> <b>D:55mm</b> <b>F:M14x1,5</b> 	<b>KPFD-0985</b> 1.X-X-X 2.X-X-X 3.X-X-X	UC2N32280 AB31.3289BA	Direita	Terminal Direito Ranger 4x2 4x4 após 2012
<b>B:M14x1,5</b> <b>E:220mm</b> <b>C:M14x1,5</b> 	<b>KPFD-0986</b> 1.X-X-X 2.X-X-X 3.X-X-X	UC2M3224XA AB31.3280AB	Direita	Barra Axial Ranger 4x2 4x4 após 2012
<b>B:M16x1,5</b> <b>E:383mm</b> <b>C:M20x1,5</b> 	<b>KPFD-0987</b> 1.X-X-X 2.X-X-X 3.X-X-X	6CL3L519AA 6CL3L519BA	Direita e Esquerda	Barra Axial Transit
 <b>A:90mm</b> <b>D:40mm</b> <b>F:M16x1,5</b>	<b>KPFD-0988</b> 1.X-X-X 2.X-X-X 3.X-X-X	6C11/3289AC	Direita	Terminal de Direção Transit
<b>A:860mm</b> <b>B:1" x 16</b> 	<b>KPFD-3380</b> 1.X-X-X 2.X-X-X 3.X-X-X	2C35.3B406BA	Esquerda	Terminal Longo da Barra Longa F250 - F350
<b>A:190mm</b> <b>B:1" x 16</b> 	<b>KPFD-3381</b> 1.X-X-X 2.X-X-X 3.X-X-X	2C35.3B407BA	Direita	Terminal Curto da Barra Longa F250 - F350
<b>A:460mm</b> <b>B:7/8" x 16</b> 	<b>KPFD-3382</b> 1.X-X-X 2.X-X-X 3.X-X-X	2C35.3289BA	Esquerda	Terminal Longo da Barra Curta F250 - F350
<b>A:160mm</b> <b>B:7/8" x 16</b> 	<b>KPFD-3383</b> 1.X-X-X 2.X-X-X 3.X-X-X	2C35.3290BA	Direita	Terminal Curto da Barra Curta F250 - F350



FIGURA	Nº Lontra	Modelos Compatíveis	Rosca	Descrição e Aplicação
<b>A:130mm</b> <b>B:7/8"x18</b> 	<b>KPFD-3399</b> 1.TS3399 2.PD3632 3.X-X-X	BF2C 3289C	Direita	Terminal de Direção da Barra Lateral Esquerda F1000 / 1992 em diante
<b>A:425mm</b> <b>B:7/8"x18</b> 	<b>KPFD-3400</b> 1.TS3400 2.PD3633 3.X-X-X	BF2C 3290C	Esquerda	Terminal de Direção da Barra Lateral Esquerda F1000 / 1992 em diante
<b>A:730mm</b> <b>B:1"x16</b> 	<b>KPFD-3406</b> 1.TS3406R 2.PD3636 3.X-X-X	BF2C 3289B	Esquerda	Terminal de Direção da Barra Central F1000 / 1992 em diante
<b>A:240mm</b> <b>B:1"x16</b> 	<b>KPFD-3409</b> 1.TS3609L 2.X-X-X 3.X-X-X	BF2C 3290B	Direita	Terminal de Direção da Barra Central F1000 / 1992 em diante
<b>A:210mm</b> <b>B:1"x16</b> 	<b>KPFD-3410</b> 1.X-X-X 2.X-X-X 3.X-X-X	2C353B406AA	Direita	Terminal de Direção da Barra Lateral (curto da barra curta) F4000 / 1999 em diante
<b>A:710mm</b> <b>B:1"x16</b> 	<b>KPFD-3411</b> 1.X-X-X 2.X-X-X 3.N2109	F813304AA	Esquerda	Terminal de Direção da Barra Lateral (longo da barra curta) F4000 / 1999 em diante
	<b>KPFD3612</b> 1-X-X-X 2-X-X-X 3-X-X-X	1C3Z3A131BA	Esquerda	Terminal Longo da Barra Longa F4000 - 1999 em diante
	<b>KPFD3613</b> 1-X-X-X 2-X-X-X 3-X-X-X	1C3Z3A131AB 3C3E3A131CA 4CZ3A131CA F81Z3A131BB	Direita	Terminal Curto da Barra Longa F4000 em diante



## Tecnologia a serviço do transporte

















FIGURA		Nº Lontra	Modelos Compatíveis	Descrição e Aplicação
KPFD218  COMPRIMENTO G:610mm	KPFD219 	<b>KPFD-215</b> 1.X-X-X 2.BD2203 3.X-X-X	C7TZ 3280B C7TZ 3280H	Lateral F350 / 400 de 1971 a 1986 F2000 / 4000 até 12/1986
KPFD224  COMPRIMENTO G:658mm	KPFD225 	<b>KPFD-223</b> 1.X-X-X 2.BD3203 3.X-X-X	86TU 3280EB	Direção F2000 / 4000 de 12/1986 a 1999
KPFD224  COMPRIMENTO G:610mm	KPFD225 	<b>KPFD-726</b> 1.X-X-X 2.BD2203 3.X-X-X	85TU3280 85TU3280B C77A3280H	Direção F4000 de 1975 a 1998
KPFD0972  COMPRIMENTO G:611mm	KPFD0971 	<b>KPFD-0971B</b> 1.BLS5971 2.BD0954 3.N241	C5TZ 3280A	Barra Lateral Esquerda F100 - F1000 / 1968 a 1991
 COMPRIMENTO G:1019mm		<b>KPFD-2056</b> 1.BLS2056 2.BD2207 3.X-X-X	C7TZ 3304GC	Central F2000 / F4000 de 1971 a 1986
 COMPRIMENTO G:1019mm		<b>KPFD-2303</b> 1.BLS2303 2.BD0958 3.N242	BE2C 3304A 79TU 3304A	Barra Central F100 - F1000 / 1968 a 1991
 COMPRIMENTO G:1030mm		<b>KPFD-3115</b> 1.BLS3115 2.BD3207 3.X-X-X	86TU 3304GB	Central F2000 / F4000 de 1987 a 1993
KPFD3406  COMPRIMENTO G:1019mm	KPFD3409 	<b>KPFD-3373</b> 1.BDS3373 2.BD3637 3.X-X-X	BF2C 3280A	Barra Central F100 - F1000 / 1992 em diante
KPFD3400  COMPRIMENTO G:608mm	KPFD3399 	<b>KPFD-3374</b> 1.BDS3374 2.BD3634 3.X-X-X	BF2C 3304A	Barra de Direção Lateral Esquerda F100 - F1000 / 1992 em diante
KPFD0976  COMPRIMENTO G:515mm	KPFD0977 	<b>KPFD-3376</b> 1.X-X-X 2.X-X-X 3.X-X-X	F2TZ 3304C	Barra de Ligação Ranger 4x2 4x4 até 1997







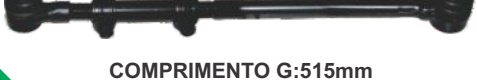



FIGURA	Nº Lontra	Modelos Compatíveis	Descrição e Aplicação
KPFD3382                      KPFD3383  COMPRIMENTO G:611mm	<b>KPFD-3377</b> 1.BDE2427 2.BD5165 3.X-X-X	-	Barra Lateral Esquerda (curta) F250 - F350
KPFD3380                      KPFD3381  COMPRIMENTO G:1010mm	<b>KPFD-3378</b> 1.BDE2428 2.BD5166 3.X-X-X	-	Barra Central (longa) F250 - F350
KPFD3377  KPFD3378 	<b>KPFD-3379</b> 1.X-X-X 2.BD5208 3.X-X-X	2C35 3B0008BA	Conjunto de Barras F250 - F350
 COMPRIMENTO G:1030mm	<b>KPFD-3495</b> 1.BLS3495 2.BD3207 3.X-X-X	T724 15701	Barra de Ligação F2000 / F4000 de 1987 a 1999
 COMPRIMENTO G:1030mm	<b>KPFD-3622</b> 1.BLS3622 2.X-X-X 3.X-X-X	2SH4 15701	Barra de Ligação F4000 de 1993 a 1999
 COMPRIMENTO G:1500mm	<b>KPFD-3623</b> 1.BLS3623 2.X-X-X 3.X-X-X	1C3Z 3A131AB/BA	Barra de Ligação F4000 de 1999 em diante 4x2
KPFD3410                      KPFD3411  COMPRIMENTO G:900mm	<b>KPFD-3624</b> 1.BLS3624 2.X-X-X 3.X-X-X	2C35 3B406AA	Barra Lateral F4000 de 1999 em diante 4x2 e 4x4
 KPFD3623 KPFD3624	<b>KPFD-3625</b> 1.X-X-X 2.X-X-X 3.N2158	1C3Z 3A131AB/BA 2C35 3B406AA 6C353B008BA	Conjunto de Barras F4000 de 1999 em diante 4x2
 COMPRIMENTO G:1475mm	<b>KPFD-3626</b> 1.X-X-X 2.X-X-X 3.X-X-X	-	Barra de Ligação F4000 4x4 e F350 4x4 de 1999 em diante
 KPFD3626 KPFD3624	<b>KPFD-3627</b> 1.X-X-X 2.X-X-X 3.N2159	6C353B008AC	Conjunto de Barras F4000 4x4 e F350 4x4 de 1999 em diante

FIGURA	Nº Lontra	Modelos Compatíveis	Descrição e Aplicação
	<b>KPFD-0735</b> 1.PS735 2.JE3631 3.X-X-X	E7TA 3B102AA E7TZZ 3049A	Pivot Superior F1000 4x2 de 1992 em diante e Ranger até 1997
	<b>KPFD-0736</b> 1.PS736 2.JE3630 3.X-X-X	E7TA 3B102DA	Pivot Inferior F1000 4x2 de 1992 em diante
	<b>KPFD-0737</b> 1.X-X-X 2.X-X-X 3.X-X-X	TNK4 07303 F5UZ 3049A	Pivot Superior F1000 4x2 até 1992 F250 / Ranger 4x2 4x4 até 1997
	<b>KPFD-0738</b> 1.X-X-X 2.X-X-X 3.X-X-X	TNK4 07301	Pivot Inferior F1000 4x2 até 1992
	<b>KPFD-0739</b> 1.X-X-X 2.X-X-X 3.X-X-X	F6TZ 3050FB	Pivot Inferior F250 - F350
	<b>KPFD-0740</b> 1.X-X-X 2.X-X-X 3.X-X-X	E3TZZ 3050AA	Pivot Inferior Ranger 4x2 até 1997
	<b>KPFD-0741</b> 1.X-X-X 2.X-X-X 3.X-X-X	5L55 3395AA	Pivot Inferior Ranger 4x2 após 1998
	<b>KPFD-0742</b> 1.X-X-X 2.X-X-X 3.X-X-X	2L5Z 3083AA F5TZ 3083A	Braço Superior da Suspensão Dianteira Esquerda Ranger 4x2 4x4 após 1998 Supercab 4x4 Dupla 4x2 4x4
	<b>KPFD-0743</b> 1.X-X-X 2.X-X-X 3.X-X-X	2L5Z 3082AA F87A 3084CA	Braço Superior da Suspensão Dianteira Direita Ranger 4x2 4x4 após 1998 Supercab 4x4 Dupla 4x2 4x4
	<b>KPFD-0745</b> 1.X-X-X 2.X-X-X 3.X-X-X	Nº da Bandeja Inferior DB39.3091.BA	Pivô da Bandeja Inferior Ranger 4x4 4x2 de 2013 em diante







FIGURA	Nº Lontra	Modelos Compatíveis	Descrição e Aplicação
	<b>KPFD-0746</b> 1.X-X-X 2.X-X-X 3.X-X-X	Nº da Bandeja Superior DB39.3084.BA	Pivô da Bandeja Superior Ranger 4x4 4x2 de 2013 em diante
	<b>KPFD-0747</b> 1.X-X-X 2.X-X-X 3.X-X-X	YC153468AF	Pivô da Bandeja Superior Transit
	<b>KPFD-0748</b> 1.X-X-X 2.X-X-X 3.X-X-X	BF8T3049A-5	Pivot da Suspensão Superior F4000 de 1999 de diante F450
	<b>KPFD-0749</b> 1.X-X-X 2.X-X-X 3.X-X-X	BF873049AI	Pivot da Suspensão Inferior F4000 de 1999 em diante
	<b>KPFD-0750</b> 1.X-X-X 2.X-X-X 3.X-X-X	BF873049A	KIT de Pivot da Suspensão Superior / Inferior F4000 de 1999 em diante















FIGURA	Nº Lontra	Modelos Compatíveis	Descrição e Aplicação
	<b>KPCZ-120</b> SPI.:5310X ST.:CZ120 MP.:CR1018	83PU 4758A	Cruzeta do Cardan Pampa 4x4
	<b>KPCZ-121</b> SPI.:5353X ST.:CZ121 MP.:CR1001	86D7 039A BCOC 7039A CD4D 7039A BE2C 7039A	Cruzeta do Cardan F1000 - F350 - F1000 Jeep - F75 Rural Willys
	<b>KPCZ-210</b> SPI.:5310X ST.:CZ210 MP.:CR1018	ACOT 7039A	Cruzeta do Cardan F1000 - F4000
	<b>KPCZ-252</b> SPI.:5273X ST.:CZ252 MP.:CR1003	BD2Y 47039A	Cruzeta do Cardan F350 - F400 - F1000 F2000 - F4000
	<b>KPCZ-291</b> SPI.:5618X ST.:X-X-X MP.:X-X-X	-	Cruzeta do Cardan F1000 - Ranger
	<b>KPCZ-292</b> SPI.:5641X ST.:X-X-X MP.:X-X-X	-	Cruzeta do Cardan F250 - F350

FIGURA	Nº Lontra	Modelos Compatíveis	Rosca	Descrição e Aplicação
<b>A:105mm</b> <b>B:5/8"x18</b> 	<b>KPG-3117</b> 1.TS3117L 2.PD0288 3.X-X-X	3826596 9297515 7317470	Esquerda	Terminal de Direção Curto A/C/D10 - 20 até 1987
<b>A:170mm</b> <b>B:5/8"x18</b> 	<b>KPG-3118</b> 1.TS3118R 2.PD1100 3.N304	9297514	Direita	Terminal de Direção Longo A/C/D10 - 20 até 1987
<b>A:220mm</b> <b>B:11/16"x18</b> 	<b>KPG-3251</b> 1.TS3251L 2.PD3642 3.N336	3986724 94648487	Esquerda	Terminal de Direção A/C/D10 - 20 a partir de 1988 Bonanza de 1988 Silverado de 1997 em diante
<b>A:155mm</b> <b>B:11/16"x18</b> 	<b>KPG-3252</b> 1.TS3252R 2.PD3646 3.N356	52252914	Direita	Terminal de Direção A/C/D10 - 20 a partir de 1988 Bonanza de 1988 Silverado de 1997 em diante
<b>A:210mm</b> <b>B:11/16"x18</b> 	<b>KPG-4036</b> 1.X-X-X 2.PD4317 3.X-X-X	26033089	Direita	Terminal de Direção Longo S10 e Blazer
<b>A:125mm</b> <b>B:11/16"x18</b> 	<b>KPG-4037</b> 1.X-X-X 2.PD4309 3.X-X-X	26033088	Esquerda	Terminal de Direção Curto S10 e Blazer
<b>A:77mm</b> <b>D:40mm</b> <b>F:M14x1,5</b> 	<b>KPG-4045</b> 1.X-X-X 2.X-X-X 3.X-X-X	94772911	Direita	Terminal de Direção S10 Nova após 2012



FIGURA	Nº Lontra	Modelos Compatíveis	Descrição e Aplicação
 <p>KPG3117                      KPG3118</p> <p>COMPRIMENTO G:399mm</p>	<b>KPG-1049</b> 1.BLS1049 2.BD1072 3.N301	9297512 9297513	Barra de Direção Lateral Direita A/C/D10 - 20 - C14 - C15 - C16 Veraneio até 1987
 <p>KPG3118                      KPG3117</p> <p>COMPRIMENTO G:399mm</p>	<b>KPG-1050</b> 1.BLS3120 2.BD1068 3.N301	7324559	Barra de Direção Lateral Esquerda A/C/D10 - 20 - C14 - C15 - C16 Veraneio até 1987
 <p>KPG3251                      KPG3252</p> <p>COMPRIMENTO G:399mm</p>	<b>KPG-3249</b> 1.BLS3249 2.BD3619 3.N352	52286801	Barra de Direção Lateral Direita A/C/D10 - 20, Veraneio Bonanza de 1988 em diante Silverado de 1997 em diante
 <p>KPG3251                      KPG3252</p> <p>COMPRIMENTO G:399mm</p>	<b>KPG-3250</b> 1.BLS3250 2.BD3619 3.N352	52286801	Barra de Direção Lateral Esquerda A/C/D10 - 20, Veraneio Bonanza de 1988 em diante Silverado de 1997 em diante
 <p>KPG4037                      KPG4036</p> <p>COMPRIMENTO G:364mm</p>	<b>KPG-4040</b> 1.BLS4040 2.X-X-X 3.X-X-X	-	Barra de Direção Lateral Direita e Esquerda S10 e Blazer de 1996 em diante
 <p><b>B:M14x1,5</b> <b>C:M18x1,5</b></p> <p>COMPRIMENTO E:335mm</p>	<b>KPG-4041</b> 1.X-X-X 2.X-X-X 3.X-X-X	94772911	Barra Axial S10 Nova após 2012



# Tecnologia a serviço do transporte















FIGURA	Nº Lontra	Modelos Compatíveis	Descrição e Aplicação
	<b>KPG-080</b> 1.PS80 2.JE1770 3.N318	52258111 7323877 7330710	Pivot Superior C10 - C20 - D10 - D20 C14 - C15 - C16 de 1964 a 1993
	<b>KPG-167</b> 1.PS167 2.JE1769 3.N319	52258112 7323878 9304148	Pivot Inferior C10 - C20 - D10 - D20 C14 - C15 - C16 de 1964 a 1993
	<b>KPG-703</b> 1.PS703 2.JE3617 3.N337	93213068 94630474	Pivot Superior A/C/D20 - Veraneio a partir de 1993 A/C/D40 de 1985 em diante Silverado de 1997 em diante
	<b>KPG-707</b> 1.PS707 2.JE3610 3.N338	93213067 94630475	Pivot Inferior A/C/D20 - Veraneio a partir de 1993 A/C/D40 de 1985 em diante Silverado de 1997 em diante
	<b>KPG-848</b> 1.PS848 2.X-X-X 3.X-X-X	93281740 93230827 92328935	Pivot Inferior S10 e Blazer 4x2 4x4 de 1996 em diante
	<b>KPG-867</b> 1.PS867 2.X-X-X 3.X-X-X	93292476	Pivot Superior S10 e Blazer 4x2 4x4 de 1996 em diante
	<b>KPG-870</b> 1.PS870 2.X-X-X 3.X-X-X	93331416	Pivot Inferior S10 e Blazer 4x2 de 2002 em diante
	<b>KPG-875</b> 1.PS875 2.X-X-X 3.X-X-X	93328935 93331496 93314316	Pivot Superior S10 e Blazer 4x2 de 2002 em diante
	<b>KPG-900</b> 1.X-X-X 2.X-X-X 3.X-X-X	94727113	Pivot Inferior Pino Oscilante de 20,70mm S10 Nova após 2012 a 2016
	<b>KPG-901</b> 1.X-X-X 2.X-X-X 3.X-X-X	94727114	Pivot Superior Pino Oscilante de 17,55mm S10 Nova após 2012 a 2016



FIGURA	Nº Lontra	Modelos Compatíveis	Descrição e Aplicação
	<b>KPG-6000</b> 1-328.26.028SCG 2-X-X-X 3-N3057	260.46.110CG	Braço Pitman S-10 e Blazer DE 1995 A 2009 (Cabeça Grande)
	<b>KPG-6001</b> 1-328.026.028SCP 2-X-X-X 3-X-X-X	260.46.110CP	Braço Pitman S10 2010 - 2011 (Cabeça Pequena)
	<b>KPG-6010</b> 1-328.26.001 2-X-X-X 3-X-X-X	3817956	Braço Auxiliar A/C/D10 até 1984
	<b>KPG-6020</b> 1.X-X-X 2-X-X-X 3-N6020	3767052	Braço Pitman da Direção Mec. A/C/D-10-14-16 até 1984
	<b>KPG-6021</b> 1-328.26.021R 2-X-X-X 3-N3036	94634079	Braço Pitman da Direção Mec. A/C/D-10-20 de 1985 em diante
	<b>KPG-6022</b> 1-328.26.022R 2-X-X-X 3-N3039	94634078	Braço Auxiliar da Direção Mec. DHB/ZF A/C/D10-20, Veraneio Bonanza de 1985 em diante Silverado de 1997 em diante
	<b>KPG-6023</b> 1-328.26.023R 2-X-X-X 3-X-X-X	94651679	Braço Pitman da Direção Mec. ZF A/C/D10-20, Veraneio Bonanza de 1985 em diante Silverado de 1997 em diante
	<b>KPG-6027</b> 1-328.26.027R 2-X-X-X 3-N3037	52256814	Braço Auxiliar da Direção Mec. DHB/A/C/D10-20, Veraneio Bonanza de 1985 em diante Silverado de 1997 em diante
	<b>KPG-6029</b> 1-328.26.029R 2-X-X-X 3-N3058	93360627	Braço Auxiliar S-10 e Blazer
	<b>KPG-8007</b> 1-328.26.007R 2-X-X-X 3-X-X-X	94644439	Braço Pitman da Direção A/C/D40 de 1985 em diante
	<b>KPG-8008</b> 1-328.28.008R 2-X-X-X 3-X-X-X	94644440	Braço Auxiliar da Direção A/C/D40 de 1985 em diante

FIGURA	Nº Lontra	Modelos Compatíveis	Descrição e Aplicação
	<b>KPCZ-121</b> SPI.:5153X ST.:CZ121 MP.:CR1018	7352431 7364605 94622086	Cruzeta do Cardan C10 - C14 - C15 - D10 - D14 Bonanza
	<b>KPCZ-210</b> SPI.:5160X ST.:CZ210 MP.:CR1004	7634605	Cruzeta do Cardan C10 - C14 - C15 - D10 - D14 Bonanza - Grand Blazer - Silverado
	<b>KPCZ-256</b> SPI.:5275X ST.:CZ256 MP.:CR1006	522700196	Cruzeta do Cardan A10 - C10





## Tecnologia a serviço do transporte



FIGURA	Nº Lontra	Modelos Compatíveis	Rosca	Descrição e Aplicação
<b>A:90mm</b> <b>B:11/16"x16</b> 	<b>KPL-010</b> 1.X-X-X 2.X-X-X 3.X-X-X	RTC 5870	Esquerda	Terminal de Direção Defender 90/110 SW - CSW
<b>A:90mm</b> <b>B:11/16"x16</b> 	<b>KPL-020</b> 1.X-X-X 2.X-X-X 3.X-X-X	RTC 5869	Direita	Terminal de Direção Defender 90/110 SW - CSW

 de utilitários do fabricante Land Rover  
**Barras de Direção**

FIGURA	Nº Lontra	Modelos Compatíveis	Descrição e Aplicação
<b>KPL030</b> <b>KPL040</b>  COMPRIMENTO G: 	<b>KPL-030</b> 1.X-X-X 2.X-X-X 3.X-X-X	NRC 9742	Barra de Direção Completa Defender 90/110 SW - CSW
	<b>KPL-040</b> 1.X-X-X 2.X-X-X 3.X-X-X	-	Tubo da Barra de Direção Defender 90/110 SW - CSW

 de utilitários do fabricante Land Rover  
**Cruzeta**

FIGURA	Nº Lontra	Modelos Compatíveis	Descrição e Aplicação
	<b>KPCZ-201</b> SPI.:5-4X ST.:CZ201 MP.:CR1062	-	Cruzeta do Cardan Pick-up - Defender











FIGURA	Nº Lontra	Modelos Compatíveis	Rosca	Descrição e Aplicação
<b>A:87,00mm</b> <b>D:40,00</b> <b>F:M16x1,5</b> 	<b>KPVW-001</b> 1.X-X-X 2.X-X-X 3.X-X-X	2HO422817	Direita	Terminal de Direção Amarok 2010/...
<b>A:87,00mm</b> <b>D:40,00</b> <b>F:M16x1,5</b> 	<b>KPVW-002</b> 1.X-X-X 2.X-X-X 3.X-X-X	2HO422818	Direita	Terminal de Direção Amarok 2010/...
<b>B:M16x1,5</b> <b>C:M16x1,5</b> <b>E:305mm</b> 	<b>KPVW-003</b> 1.X-X-X 2.X-X-X 3.X-X-X	sem número original	Direita	Barra Axial Amarok
	<b>KPVW-004</b> 1.X-X-X 2.X-X-X 3.X-X-X	2HO419804	Lado Direito	Barra Axial com Terminal Direito Amarok 2010/...
	<b>KPVW-005</b> 1.X-X-X 2.X-X-X 3.X-X-X	2HO419803	Lado Esquerdo	Barra Axial com Terminal Esquerdo Amarok 2010/...
	<b>KPVW-008</b> 1.X-X-X 2.X-X-X 3.X-X-X	Nº Original da Bandeja: 2HO407.152A	Superior	Pivô Superior Amarok 2010/...
	<b>KPVW-009</b> 1.X-X-X 2.X-X-X 3.X-X-X	Nº Original da Bandeja: 2HO407.022B	Inferior	Pivô Inferior Amarok 2010/...



FIGURA	Nº Lontra	Modelos Compatíveis	Rosca	Descrição e Aplicação
<b>A:95mm</b> <b>D:40mm</b> <b>F:M14x1,5</b> 	<b>KPN-001</b> 1.X-X-X 2.X-X-X 3.X-X-X	48570.3S525	Esquerda Interna	Terminal de Direção Frontier de 1998 a 2004
<b>A:95mm</b> <b>D:40mm</b> <b>F:M14x1,5</b> 	<b>KPN-002</b> 1.X-X-X 2.X-X-X 3.X-X-X	48520.3S523	Direita Interna	Terminal de Direção Frontier de 1998 a 2004
 <b>G:270mm</b>	<b>KPN-003</b> 1.BLE4639 2.BD5155 3.X-X-X	4851035526 D8510VK90A		Barra de Direção Frontier 4x4 de 1998 em diante
	<b>KPN-004</b> 1.X-X-X 2.X-X-X 3.X-X-X	485603S525		Barra de Direção Central Frontier 4x4 de 1998 a 2007

 de utilitários do fabricante Nissan  
 Pivot de Suspensão, Braços e Cruzetas

















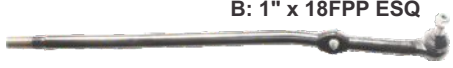
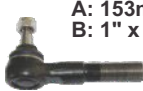

FIGURA	Nº Lontra	Modelos Compatíveis	Descrição e Aplicação
	<b>KPN-005</b> 1.X-X-X 2.X-X-X 3.X-X-X	40.160.25601	Pivot Inferior Frontier até 2007
	<b>KPN-006</b> 1.X-X-X 2.X-X-X 3.X-X-X	40110VJ200	Pivot Superior Frontier de 1998 a 2007
	<b>KPN-007</b> 1.X-X-X 2.X-X-X 3.X-X-X	54500-E870A PART	Pivot Inferior de 2008 em diante
	<b>KPN-010</b> 1.X-X-X 2.X-X-X 3.X-X-X	48.530-31G25	Braço Auxiliar Frontier até 2002 Pathfinder de 1987 a 1995
	<b>KPN-011</b> 1.X-X-X 2.X-X-X 3.X-X-X	48530-3S 525 D8530-VK90A	Braço Auxiliar Frontier de 2003 em diante X Terra de 2000 a 2004
	<b>KPCZ-324</b> SPI.:X-X-X ST.:X-X-X MP.:X-X-X	371255000	Cruzeta do Cardan Dianteiro e Traseiro Frontier até 2007
	<b>KPCZ-324</b> SPI.:X-X-X ST.:CZ293 MP.:X-X-X	4914043001	Cruzeta do Cardan Dianteiro Frontier de 2000 a 2018 (atual)
	<b>KPCZ-327</b> SPI.:X-X-X ST.:CZ293 MP.:X-X-X	3712518025	Cruzeta do Cardan Traseiro Frontier após 2008

FIGURA	Nº Lontra	Modelos Compatíveis	Descrição e Aplicação
 <p>A: 168mm B: 1" x 18FPP DIR</p>	<b>KPD-1000</b> 1.X-X-X 2.X-X-X 3.X-X-X	-	Terminal curto da barra curta Dodge RAM 2500 até 2008
 <p>A: 845mm B: 1" x 18FPP ESQ</p>	<b>KPD-1001</b> 1.X-X-X 2.X-X-X 3.X-X-X	-	Terminal longo barra curta Dodge RAM 2500 até 2008
 <p>A: 153mm B: 1" x 18FPP DIR</p>	<b>KPD-1002</b> 1.X-X-X 2.X-X-X 3.X-X-X	-	Terminal curto da barra longa Dodge RAM 2500 até 2008
 <p>A: 1185mm B: 1" x 18FPP ESQ</p>	<b>KPD-1003</b> 1.X-X-X 2.X-X-X 3.X-X-X	-	Terminal longo da barra longa Dodge RAM 2500 até 2008
 <p>KPD-1001                      KPD-1000 G: 1023mm</p>	<b>KPD-2300</b> 1.X-X-X 2.X-X-X 3.X-X-X	-	Barra de Direção Lateral (curta) Dodge RAM 2500 até 2008
 <p>KPD-1003                      KPD-1002 G: 1348mm</p>	<b>KPD-2301</b> 1.X-X-X 2.X-X-X 3.X-X-X	-	Barra de Ligação (longa) Dodge RAM 2500 até 2008
 <p>KPD-2300 KPD-2301</p>	<b>KPD-2302</b> 1.X-X-X 2.X-X-X 3.X-X-X	-	Conjunto de Barras de Direção Dodge RAM 2500 até 2008
 <p>KPD-3403                      KPD-3402 G: 1023mm</p>	<b>KPD-3300</b> 1.X-X-X 2.X-X-X 3.X-X-X	-	Barra de Direção Lateral (curta) Dodge RAM 2500 de 2009 em diante
 <p>KPD-3401                      KPD-3400 G: 1348mm</p>	<b>KPD-3301</b> 1.X-X-X 2.X-X-X 3.X-X-X	-	Barra de Ligação (longa) Dodge RAM 2500 de 2009 em diante
 <p>KPD-3300 KPD-3301</p>	<b>KPD-3302</b> 1.X-X-X 2.X-X-X 3.X-X-X	52122362AE	Conjunto de Barras de Direção Dodge RAM 2500 de 2009 em diante

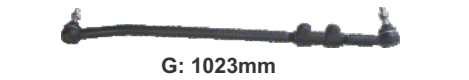
## Tecnologia a serviço do transporte

FIGURA	Nº Lontra	Modelos Compatíveis	Descrição e Aplicação
KPM702  COMPRIMENTO G:665mm	<b>KPM-935</b> 1.X-X-X 2.X-X-X 3.X-X-X	6313300603	Barra de Direção Transversal (média) MB 180
KPM700      KPM701  COMPRIMENTO G:280mm	<b>KPM-936</b> 1.X-X-X 2.X-X-X 3.X-X-X	6313300703	Barra de Direção da Roda (média) MB 180
KPM703  COMPRIMENTO G:1230mm	<b>KPM-937</b> 1.X-X-X 2.X-X-X 3.X-X-X	6314600705	Barra de Direção Longitudinal (grande) MB 180

 de utilitários do fabricante Mercedes Benz  
**Terminais de Direção**



FIGURA	Nº Lontra	Modelos Compatíveis	Rosca	Descrição e Aplicação
<b>A:88,5mm</b> <b>B:M20x1,5</b> 	<b>KPM-700</b> 1.X-X-X 2.X-X-X 3.X-X-X	6313300435	Esquerda	Da Barra Pequena da Roda MB 180
<b>A:88,5mm</b> <b>B:M20x1,5</b> 	<b>KPM-701</b> 1.X-X-X 2.X-X-X 3.X-X-X	0013304835	Direita	Da Barra Pequena da Roda MB 180
<b>A:105mm</b> <b>B:M24x1,5</b> 	<b>KPM-702</b> 1.X-X-X 2.X-X-X 3.X-X-X	6313300535	Direita	Da Barra Transversal Média MB 180













FIGURA	Nº Lontra	Modelos Compatíveis	Rosca	Descrição e Aplicação
<b>A:65mm</b> <b>B:M18x1,5</b> 	<b>KPM-703</b> 1.X-X-X 2.X-X-X 3.X-X-X	0004606548	Direita	Barra Longitudinal (comprida) MB 180
<b>A:78mm</b> <b>D:40mm</b> <b>F:M16x1,5</b> 	<b>KPM-704</b> 1.X-X-X 2.X-X-X 3.X-X-X	9014600148	Direita	Sprinter
	<b>KPM-705</b> 1.X-X-X 2.X-X-X 3.X-X-X	9013331127	Pivot	Sprinter
<b>B:M16x1,5</b> <b>E:395mm</b> <b>C:M16x1,5</b> 	<b>KPM-707</b> 1.X-X-X 2.X-X-X 3.X-X-X	9014600205	Direita	Haste de Direção Hidráulica Sprinter
<b>A:91mm</b> <b>D:44mm</b> <b>F:M16x1,5</b> 	<b>KPM-708</b> 1.X-X-X 2.X-X-X 3.X-X-X	9064600348	Direita	Terminal de Direção Sprinter 315-415 de 2013 em diante
	<b>KPM-709</b> 1.X-X-X 2.X-X-X 3.X-X-X	NÚMERO ORIGINAL DAS BANDEJAS 9063304007 9063304107	Pivot	Pivot de Suspensão Sprinter 315-415 de 2013 em diante
<b>B:M16x1,5</b> <b>E:395mm</b> <b>C:M18x1,5</b> 	<b>KPM-710</b> 1.X-X-X 2.X-X-X 3.X-X-X	9604600155	Direita	Haste de Direção Hidráulica Sprinter 315-415 de 2013 em diante
	<b>KPM-211</b> 1.X-X-X 2.X-X-X 3.X-X-X	6313340253	-	Separador do Rolam. do Cubo MB 180
	<b>KPM-212</b> 1.X-X-X 2.X-X-X 3.X-X-X	9013200289	Direita	Bieleta Sprinter 310 / 312
	<b>KPM-213</b> 1.X-X-X 2.X-X-X 3.X-X-X	9013200389	Esquerda	Bieleta Sprinter 310 / 312

FIGURA	Nº Lontra	Modelos Compatíveis	Descrição e Aplicação
	<p><b>KPCZ-210</b> SPI.:5160X ST.:CZ210 MP.:CR1004</p>	<p>0004101231</p>	<p>Cruzeta do Cardan Sprinter</p>



**Tecnologia a serviço do transporte**

FIGURA	Nº Lontra	Modelos Compatíveis	Rosca	Descrição e Aplicação
<b>A:160mm</b> <b>D:55mm</b> <b>F:M14x1,5</b> 	<b>KPK-100</b> 1.X-X-X 2.X-X-X 3.X-X-X	S-0K71032240	Direita Interna	Topic 2.7 Besta 2.2 - 2.7
<b>A:110mm</b> <b>D:54mm</b> <b>F:M14x1,5</b> 	<b>KPK-105</b> 1.X-X-X 2.X-X-X 3.X-X-X	S-0K72A32240	Direita	Besta GS
	<b>KPK-110</b> 1.X-X-X 2.X-X-X 3.X-X-X	S-0K71034540	Pivot Superior	Topic 2.7 Besta 2.2 - 2.7
	<b>KPK-120</b> 1.X-X-X 2.X-X-X 3.X-X-X	S-0K71034510	Pivot Inferior	Topic 2.7 Besta 2.2 - 2.7
	<b>KPK-121</b> 1.X-X-X 2.X-X-X 3.X-X-X	S-0K72A34510A	Pivot Inferior	Besta GS
	<b>KPK-122</b> 1.X-X-X 2.X-X-X 3.X-X-X	OK72A34200A	-	Braço Superior da Suspensão Lado Direito e Esquerdo Besta GS
<b>B:M14x1,5</b> <b>E:185mm</b> <b>C:M17x1,00</b> 	<b>KPK-130</b> 1.X-X-X 2.X-X-X 3.X-X-X	S-0SA3932115	Direita	Topic 2.7 Besta 2.2 - 2.7

 de utilitários do fabricante Kia  
 Cruzetas













FIGURA	Nº Lontra	Modelos Compatíveis	Descrição e Aplicação
	<b>KPCZ-171</b> SPI.:X-X-X ST.:CZ171 MP.:X-X-X	ONO102.5060A 175.725.060	Cruzeta do Cardan Besta - Topic até 1994
	<b>KPCZ-172</b> SPI.:X-X-X ST.:CZ210 MP.:X-X-X	OWO102.5060A 0164-25060	Cruzeta do Cardan Besta - Topic após 1995
	<b>KPCZ-210</b> SPI.:X-X-X ST.:CZ294 MP.:X-X-X	-	Cruzeta do Cardan Besta

FIGURA	Nº Lontra	Modelos Compatíveis	Rosca	Descrição e Aplicação	
<b>A:76mm</b> <b>D:45mm</b> <b>F:M14x1,5</b> 	<b>KPH-010</b>	1.X-X-X 2.X-X-X 3.X-X-X	56872 43000	Direita Interna	Terminal de Direção H 100
<b>A:72,5mm</b> <b>D:45mm</b> <b>F:M16x1,5</b> 	<b>KPH-011</b>	1.X-X-X 2.X-X-X 3.X-X-X	56820 47500	Direita Interna	Terminal de Direção HR 2.5 de 2006 em diante
<b>A:170mm</b> <b>D:40mm</b> <b>F:M16x1,5</b> 	<b>KPH-012</b>	1.X-X-X 2.X-X-X 3.X-X-X	56820 2E000	Direita Interna	Terminal de Direção Tucson
<b>A:170mm</b> <b>D:40mm</b> <b>F:M16x1,5</b> 	<b>KPH-013</b>	1.X-X-X 2.X-X-X 3.X-X-X	56820 2E900	Direita Interna	Terminal de Direção Tucson
	<b>KPH-020</b>	1.X-X-X 2.X-X-X 3.X-X-X	54417 3001	Pivot	Pivot Superior H 100 HR 2.5 de 2006 em diante
	<b>KPH-030</b>	1.X-X-X 2.X-X-X 3.X-X-X	54542 4301	Pivot	Pivot Inferior H 100 HR 2.5 de 2006 em diante
<b>B:M14x1,5</b> <b>C:M16x1,5</b> <b>E:310mm</b> 	<b>KPH-040</b>	1.X-X-X 2.X-X-X 3.X-X-X	56542 4301	Direita	Terminal de Direção H 100
<b>B:M16x1,5</b> <b>C:M16x1,5</b> <b>E:310mm</b> 	<b>KPH-041</b>	1.X-X-X 2.X-X-X 3.X-X-X	577.304.F000	Direita	Barra de Direção HR 2.5 de 2006 em diante
<b>B:M16x1,5</b> <b>C:M16x1,5</b> <b>E:245mm</b> 	<b>KPH-042</b>	1.X-X-X 2.X-X-X 3.X-X-X	57724 2E00	Direita	Barra de Direção Tucson

## Tecnologia a serviço do transporte



FIGURA	Nº Lontra	Modelos Compatíveis	Descrição e Aplicação
	<p><b>KPCZ-170</b> SPI.:X-X-X ST.:CZ170 MP.:X-X-X</p>	<p>49140 43001</p>	<p>Cruzeta do Cardan H100 - HR205</p>

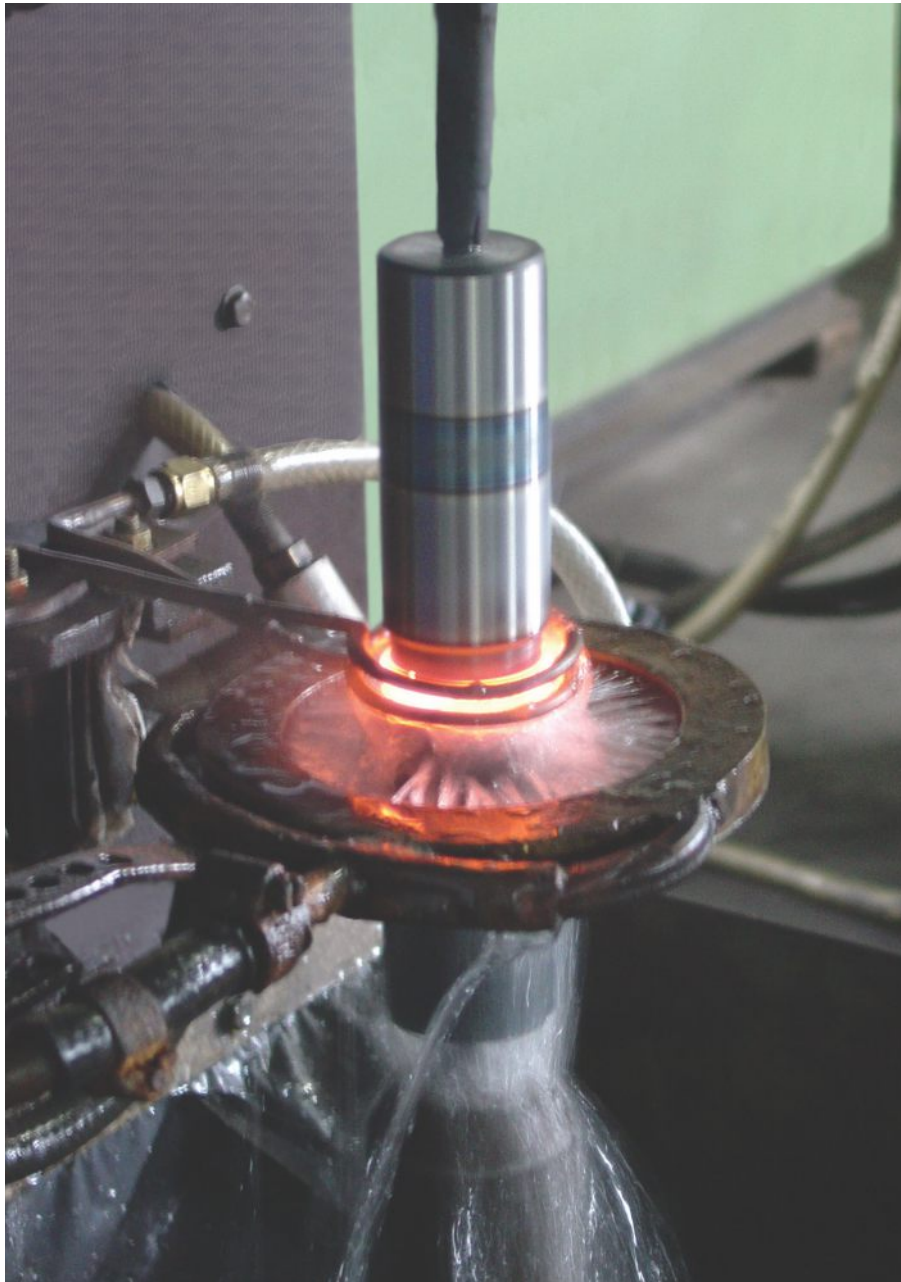

**Tecnologia a serviço do transporte**





FIGURA	Nº Lontra	Modelos Compatíveis	Rosca	Descrição e Aplicação
<b>A:76mm</b> <b>D:45mm</b> <b>F:M20x1,5</b> 	<b>KPI-010</b> 1.X-X-X 2.X-X-X 3.X-X-X	93802209	Direita Interna	Suspensão Dianteira Daily
	<b>KPI-020</b> 1.X-X-X 2.X-X-X 3.X-X-X	93807545	Pivot	Pivot da Suspensão Daily
	<b>KPI-021</b> 1.X-X-X 2.X-X-X 3.X-X-X	504212584		Pivot de Suspensão Daily 35.514 - 55.016 70.016 - 70.017 2008 até 2018
<b>A:80mm</b> <b>D:45mm</b> <b>F:M16x1,5</b> 	<b>KPI-030</b> 1.X-X-X 2.X-X-X 3.X-X-X	1903652 9380062	Direita Interna	Terminal de Direção Hidráulica Daily até 1999
<b>A:80mm</b> <b>D:45mm</b> <b>F:M16x1,5</b> 	<b>KPI-031</b> 1.X-X-X 2.X-X-X 3.X-X-X	93827647	Direita Interna	Terminal de Direção Hidráulica Daily após 2000
<b>B:M16x1,5</b> <b>C:M16x1,5</b> <b>E:340mm</b> 	<b>KPI-040</b> 1.X-X-X 2.X-X-X 3.X-X-X	42532977	Direita	Haste Esférica Daily

FIGURA	Nº Lontra	Modelos Compatíveis	Rosca	Descrição e Aplicação
	<b>KPF-010</b> 1.X-X-X 2.X-X-X 3.X-X-X	1331640080	Pivot	Suspensão Dianteira Ducato (Pino oscilante fino)
	<b>KPF-011</b> 1.X-X-X 2.X-X-X 3.X-X-X	1331641080	Pivot	Suspensão Dianteira Ducato (Pino oscilante grosso)
<b>A:120mm</b> <b>D:40mm</b> <b>F:M16x1,5</b> 	<b>KPF-020</b> 1.X-X-X 2.X-X-X 3.X-X-X	1306716080	Direita	Terminal de Direção Hidráulica Ducato
<b>A:120mm</b> <b>D:50mm</b> <b>F:M16x1,5</b> 	<b>KPF-021</b> 1.X-X-X 2.X-X-X 3.X-X-X	77362278	Direita	Terminal de Direção Ducato de 2003 em diante
<b>B:M16x1,5</b> <b>C:M16x1,5</b> <b>E:320mm</b> 	<b>KPF-030</b> 1.X-X-X 2.X-X-X 3.X-X-X	1903652 9380062 9945836	Direita	Haste da Direção Hidráulica Ducato













FIGURA	Nº Lontra	Modelos Compatíveis	Rosca	Descrição e Aplicação
<b>B:M16x1,5</b> <b>C:M14x1,5</b> <b>E:180mm</b> 	<b>KPR-001</b> 1.X-X-X 2.X-X-X 3.X-X-X	-	Direita	Haste Axial Master
<b>A:225mm</b> <b>D:45mm</b> <b>F:M16x1,5</b> 	<b>KPR-002</b> 1.X-X-X 2.X-X-X 3.X-X-X	770.147.0364	Direita	Terminal de Direção Master
<b>A:225mm</b> <b>D:45mm</b> <b>F:M16x1,5</b> 	<b>KPR-003</b> 1.X-X-X 2.X-X-X 3.X-X-X	770.147.0363	Direita	Terminal de Direção Master
	<b>KPR-004</b> 1.X-X-X 2.X-X-X 3.X-X-X	503069	-	Pivo de Suspensão Superior Master
	<b>KPR-005</b> 1.X-X-X 2.X-X-X 3.X-X-X	503061	-	Pivo de Suspensão Inferior Master
	<b>KPR-006</b> 1.X-X-X 2.X-X-X 3.X-X-X	-	-	Pivo de Suspensão Superior e Inferior TRAFIC
	<b>KPR-007</b> 1.X-X-X 2.X-X-X 3.X-X-X	-	-	Pivo de Suspensão Inferior Moderno Master
<b>A:95mm</b> <b>B:M14x1,5</b> 	<b>KPR-008</b> 1.X-X-X 2.X-X-X 3.X-X-X	7701461770	Direita	Terminal de Direção TRAFIC



FIGURA	Nº Lontra	Modelos Compatíveis	Rosca	Descrição e Aplicação
 <p>KPA711 COMPRIMENTO G:813mm</p>	<p><b>KPA-702</b> 1.X-X-X 2.X-X-X 3.X-X-X</p>	<p>6006007016000 6007007331001</p>		<p>Micro Ônibus Volare - W5 - W6 - A6 até 2002 MA 5.5</p>
 <p>KPA710 KPA711 COMPRIMENTO G:1449mm</p>	<p><b>KPA-703</b> 1.X-X-X 2.X-X-X 3.X-X-X</p>	<p>6006007017008</p>		<p>Micro Ônibus Volare</p>
<p>A:105mm B:M28x1,5</p> 	<p><b>KPA-710</b> 1.X-X-X 2.X-X-X 3.X-X-X</p>	<p>6006007132005</p>	Direita	<p>Micro Ônibus Volare</p>
<p>A:105mm B:M28x1,5</p> 	<p><b>KPA-711</b> 1.X-X-X 2.X-X-X 3.X-X-X</p>	<p>6006007133003</p>	Esquerda	<p>Micro Ônibus Volare</p>
 <p>KPA711 COMPRIMENTO G:690mm</p>	<p><b>KPA-781</b> 1.X-X-X 2.X-X-X 3.X-X-X</p>	<p>6007007331001</p>		<p>Micro Ônibus Volare - A5 à A6 até 2002 Curva para direita</p>
 <p>KPA711 COMPRIMENTO G:665mm</p>	<p><b>KPA-782</b> 1.X-X-X 2.X-X-X 3.X-X-X</p>	<p>6008007716001</p>		<p>Micro Ônibus Volare - A5 - A6 - A8 - W8 de 2003 em diante Curva para esquerda</p>

de utilitários do fabricante Agrale  
Cruzetras

FIGURA	Nº Lontra	Modelos Compatíveis	Descrição e Aplicação
	<p><b>KPCZ-177</b> SPI.:5438X ST.:CZ177 MP.:X-X-X</p>	<p>6007009321000</p>	<p>Cruzeta do Cardan Volare - 7500 - 8000 - A8</p>
	<p><b>KPCZ-210</b> SPI.:5160X ST.:CZ210 MP.:CR1004</p>	<p>6006069009003</p>	<p>Cruzeta do Cardan 18000MA - 6000D/7000D Volare 7000DX - MA5.5T</p>
	<p><b>KPCZ-252</b> SPI.:5273X ST.:CZ252 MP.:X-X-X</p>	<p>6003009007004</p>	<p>Cruzeta do Cardan Volare - 1600 - 1800 - A8</p>
	<p><b>KPCZ-254</b> SPI.:5263X ST.:CZ254 MP.:CR1005</p>	<p>6007009321000</p>	<p>Cruzeta do Cardan 8500 Ma7 - 5T Ma8</p>
	<p><b>KPCZ-266</b> SPI.:X-X-X ST.:CZ266 MP.:X-X-X</p>	<p>6006009009003</p>	<p>Cruzeta do Cardan W5 - W6 - A6</p>